

Side view

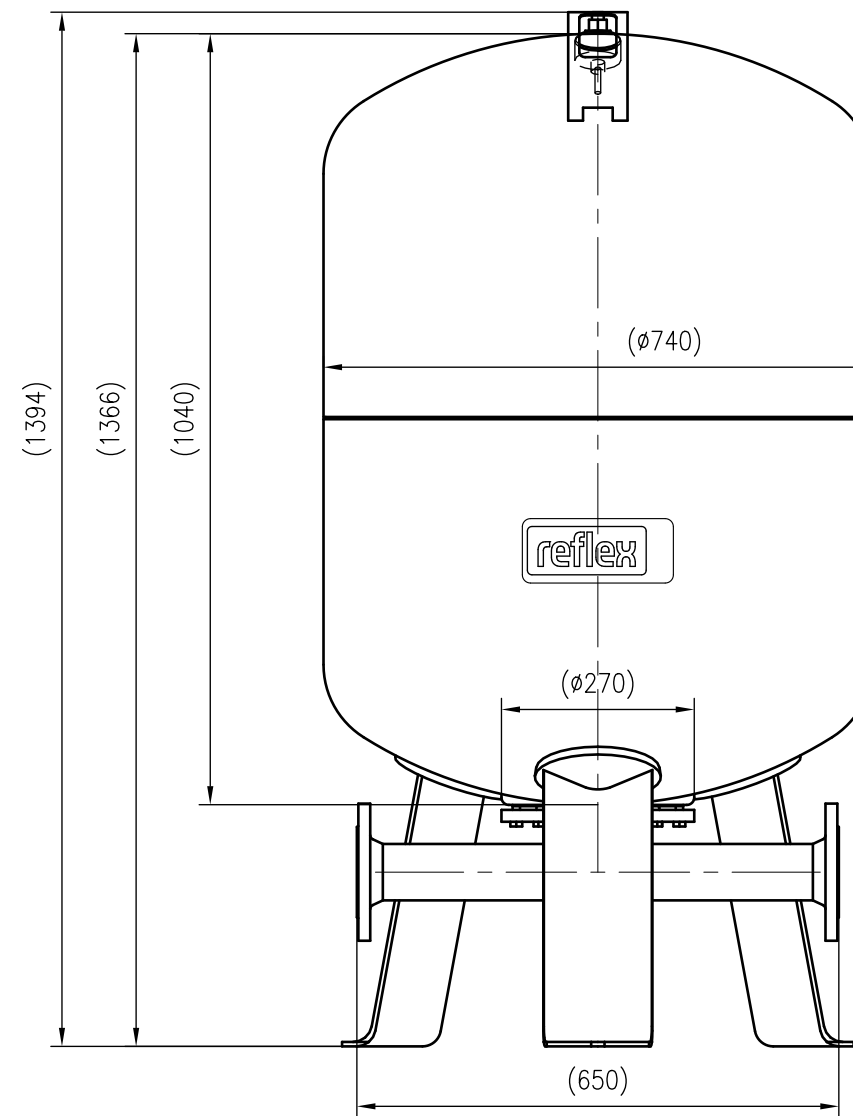

Front view

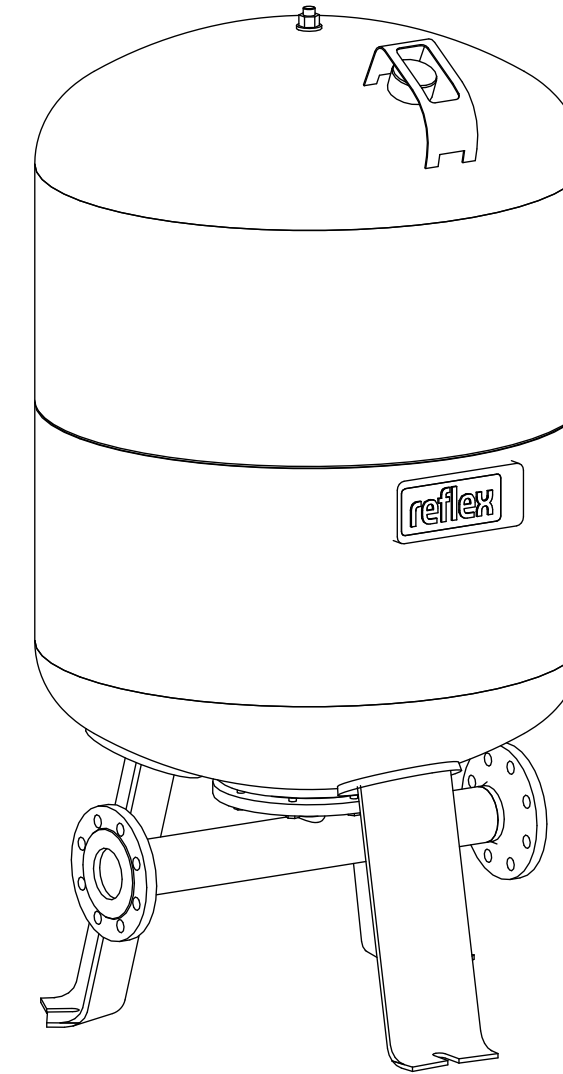

Isometric view

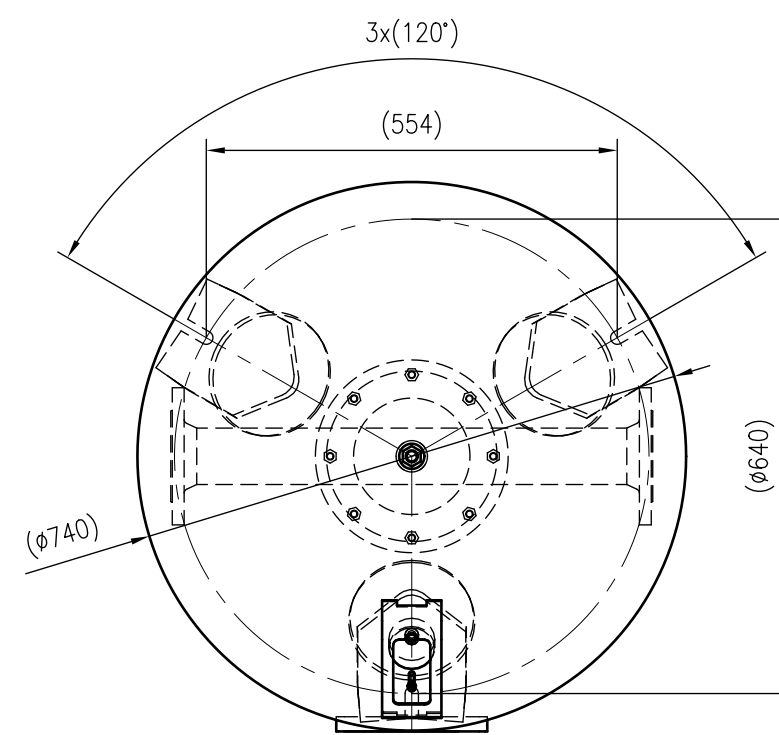

Top view



Unterliegt nicht dem Änderungsdienst/ Not subject to change management	Maßstab/ Scale: 1:10	Format/ Size: A2
Revision 19.12.2016	Reflex DT 400 16bar – 7339006	