

# PREISLISTE 2023

## UNIVERSAL-ABGASSYSTEME / SCHÄCHTE

- für Gas-, Methanol- und Öl-Brennwertkessel
- für Blockheizkraftwerke (BHKW)
- für Brennstoffzellen
- für Gaswärmepumpen
- Universelle Abgaswärmetauscher
- Abgas-Schalldämpfer
- Wärmepumpen, Schallhauben und Tieftemperatur-Heizkörper

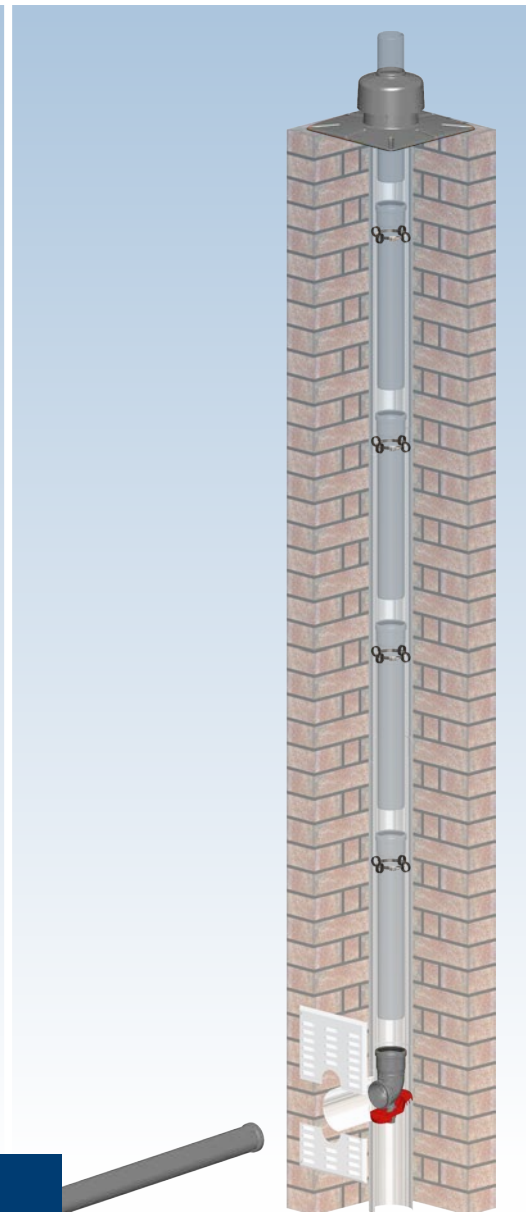

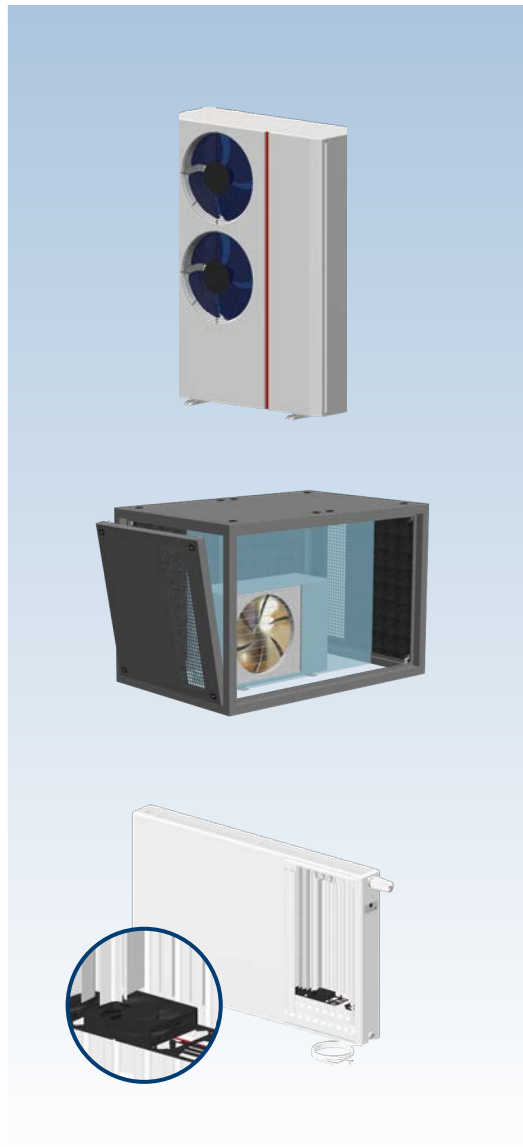
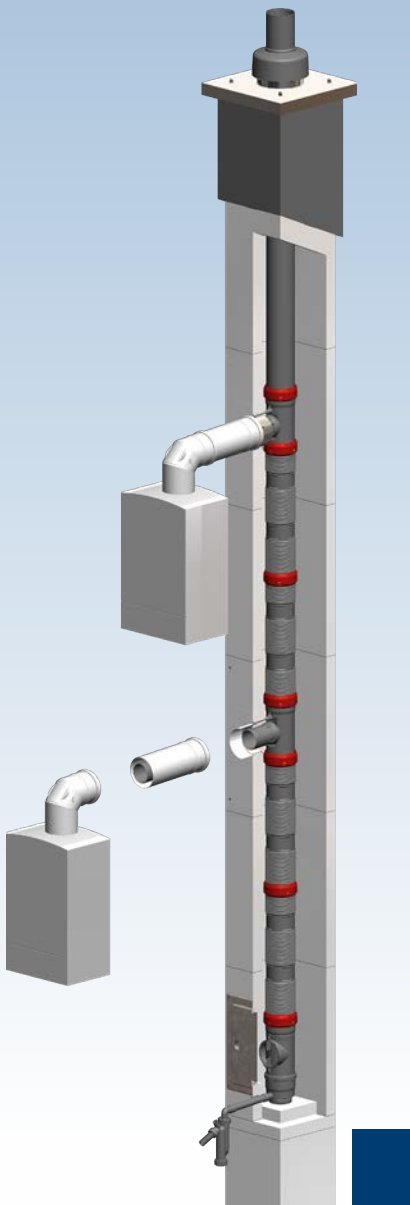

Kraftschluss-Manschette  
siehe Seite 54



T-Stücke für Kaskade  
siehe Seite 37



## eHEAT

### Wärmepumpe 12,5 kW

- Monoblock: einfache Installation
- 12,5 kW Leistung
- integrierter 80l Speicher
- perfekte Integration in Hybridkonzepte
- Regelmöglichkeiten z.B. mit WIFI oder **eCONTROL**
- leiser als 50 dB(A)

Weitere Infos im ↗ Prospekt  
Wärmepumpen  
Artikel-Nr. 10003014

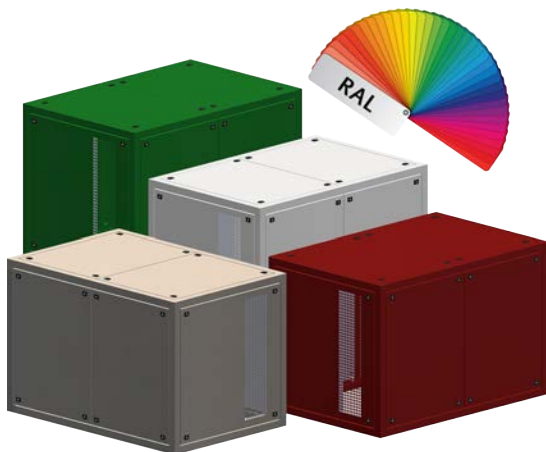
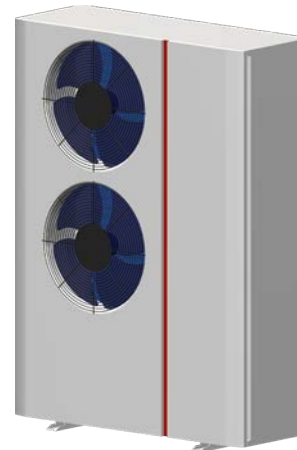

## eSILENT

### Schallhauben für Wärmepumpen, Klima- und Kälteanlagen

- bis zu -16 dB(A) Schallreduktion
- Schutz vor Vandalismus und Wetter
- hochwertige Materialien
- einfache Montage
- individuelle Fertigung
- auf Wunsch in RAL-Farbe nach Wahl

Weitere Infos im ↗ Prospekt  
Schallhauben  
Artikel-Nr. 10003130



## eVENT

### Tiefemperatur-Heizkörper

- integrierte Ventilatoren
- automatische Regelung
- für niedrige Vorlauftemperaturen

Weitere Infos im ↗ Prospekt  
Tiefemperatur-Heizkörper  
Artikel-Nr. 10001310

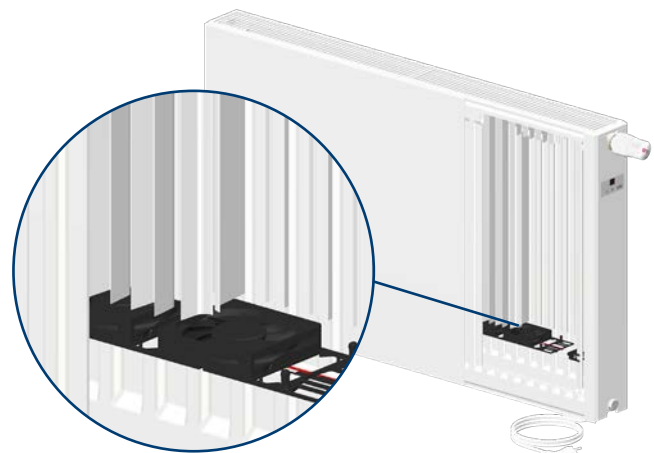

### Ihre Konditionen für Preisgruppen:

Preisgruppe 10	Preisgruppe 11	Preisgruppe 12	Preisgruppe 13	Preisgruppe 15	Preisgruppe 16	Preisgruppe 17	Preisgruppe 18

# INHALTSVERZEICHNIS

## ATEC | ABGASSYSTEME

	Seite
PRODUKTÜBERSICHT	4 – 5
ZULASSUNGEN	6
<b>EINWANDIGE – ABGASSYSTEME</b>	7 – 15
DN 60 bis DN 250 <b>PolyTop</b>	
<b>KONZENTRISCHE – ABGASSYSTEME</b>	16 – 23
DN 60/100 bis DN 110/160 <b>PolyClassic PolyTwin</b>	
<b>AUßENWAND – ABGASSYSTEME</b>	24 – 33
DN 60/100 bis DN 250/315 <b>IronPoly WhitePoly</b>	
<b>KASKADEN – ABGASSYSTEME</b>	34 – 37
für den Anschluss von bis zu 10 Feuerstätten im gleichen Aufstellraum	
<b>MEHRFACHBELEGUNG – ABGASSYSTEME</b>	38 – 45
für den Anschluss von bis zu 10 Feuerstätten in unterschiedlichen Etagen	
<b>ABGAS – SCHACHT – SYSTEME</b>	46 – 51
DN 60 bis DN 250 <b>PolyCase</b> 150 x 200 bis 420 x 420 mm Außenmaß	
<b>ABGAS – WÄRMETAUSCHER – SYSTEME</b>	52 – 53
GPH AK 28, 50, 75, GPH HP 28, 50, 75 <b>eMAX</b>	
<b>SCHALLDÄMPFER EDELSTAHL-ABGASSYSTEM</b>	54
Siehe separate Preislisten	
<b>KESSELBEZOGENE ABGASLEITUNGSBEMESSUNGEN</b>	55 – 69
<b>MAßTABELLE BAUTEILE</b>	70 – 71

# PRODUKTÜBERSICHT

## ATEC | ABGASSYSTEME

### EINWANDIGE – ABGASSYSTEME

7 – 15

DN 60 bis DN 250

**PolyTop**

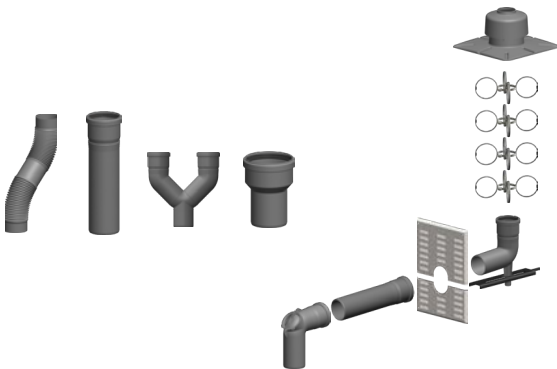

Schacht-Sets .....	7
einwandige Bauteile .....	10
Zubehör .....	12
Reduktionen und Erweiterungen .....	14

### KONZENTRISCHE – ABGASSYSTEME

16 – 23

DN 60/100 bis  
DN 110/160

**PolyClassic PolyTwin**

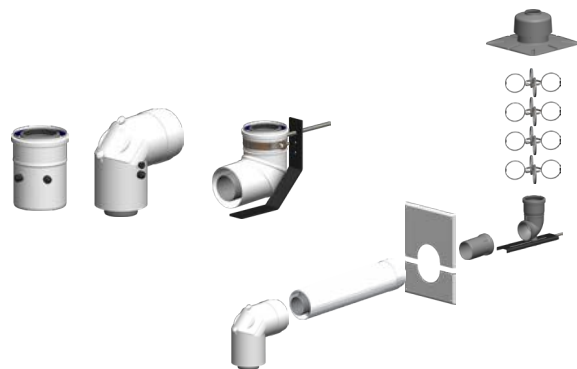

Schacht-Sets .....	16
konzentrische Bauteile .....	18
Zubehör .....	20
Kesselanschlüsse .....	21
Mündungselemente und Zubehör .....	22

### AUßENWAND – ABGASSYSTEME

24 – 33

DN 60/100 bis  
DN 250/315

**IronPoly WhitePoly**



Edelstahl weiß DN 60/100 bis DN 110/160 .....	24
Edelstahl blank DN 60/100 bis DN 110/160 .....	26
Edelstahl blank DN 125/190 bis DN 250/315 .....	28
Sonstiges .....	30
Sonderoberflächen .....	32

### KASKADEN – ABGASSYSTEME

34 – 37

für den Anschluss von bis zu 10 Feuer-  
stätten im gleichen Aufstellraum

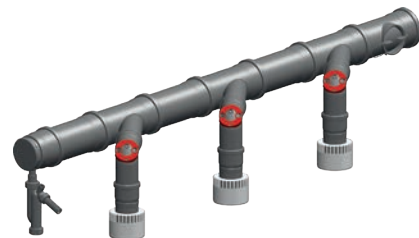

Einwandig .....	34
Konzentrisch DN 80/125 bis DN 110/160 .....	35
Konzentrisch DN 125/190 bis DN 200/265 .....	36

# PRODUKTÜBERSICHT

## ATEC | ABGASSYSTEME

### MEHRFACHBELEGUNG – ABGASSYSTEME

38 – 45

für den Anschluss von bis zu 10 Feuerstätten in unterschiedlichen Etagen



im vorhandenen Schacht DN 100, 125 und 160.....	38
im vorhandenen Schacht DN 80 und DN 110 .....	40
im Brandschutzschacht PolyBit DN 100, 125 und 160.....	42
im Brandschutzschacht PolyBit DN 80 und DN 110.....	43
an der Fassade .....	44

### ABGAS – SCHACHT – SYSTEME

46 – 51

DN 60 bis DN 250  
150 x 200 bis 420 x 420 mm Außenmaß

**PolyCase**

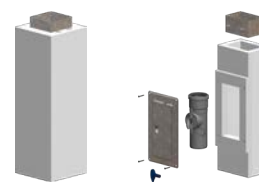

L <sub>A</sub> 30 .....	46
L <sub>A</sub> 90 .....	48

### ABGAS – WÄRMETAUSCHER – SYSTEME

52 – 53

GPH AK 28, 50, 75  
GPH HP 28, 50, 75



Wärmetauscher GPH AK .....	52
Wärmetauscher GPH HP .....	53
Zubehör .....	53

### DATEN UND BERECHNUNGEN

56 – 71

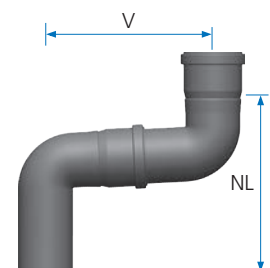
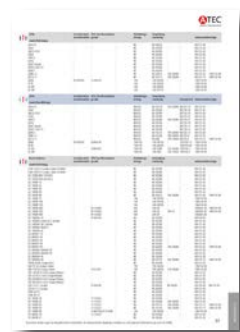

### ABGAS – SCHALLDÄMPFER – SYSTEME

54



Formular zur Querschnittsberechnung .....	55
Kesselbezogene Abgasleitungsdimensionen .....	56
Maßtabelle Einwandiges Abgassystem.....	70

### ABGASSYSTEME – EDELSTAHL

54



**Anwendungsmöglichkeiten:**

- Öl- und Gas-Brennwertfeuerstätten
- Brennwertfeuerstätten der Geräteart B (raumluftabhängig)
- Brennwertfeuerstätten der Geräteart C<sub>6</sub>, C<sub>8</sub> und C<sub>(10)</sub> (raumluftunabhängig)
- Abgaswärmetauscher
- BHKW
- Gaswärmepumpen
- Brennstoffzellen

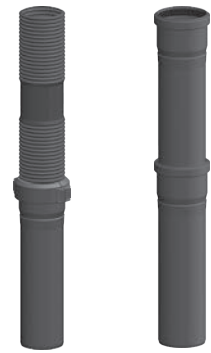

**Zulassungen/ Allgemeine Bauartgenehmigungen:**

- CE 0036 CPD 91265-001
- Z-7.5-3356 Luft-Abgas-System/Mehrfachbelegung
- Z-7.4-3396 Schachtsystem PolyCase 25 mm Wanddicke (L<sub>A</sub>30) und 40 mm Wanddicke (L<sub>A</sub>90)
- Z-7.4-3533 Schachtsystem PolyBit 50 mm Wanddicke (L<sub>A</sub>90)
- Z-7.1-3538 Abgaskaskade BHKW und Kessel mit Rückstromsicherung
- Z-43.31-222 GPH AK und HP Abgaswärmetauscher

**Werkstoff:**

Alle Abgas berührten Bauteile sind aus kondensat- und witterungsbeständigem PP (Polypropylen) hergestellt und für Abgastemperaturen bis 120°C zugelassen.

**Verbindungstechnik:**

Die Verbindung der Bauteile erfolgt mittels Steckmuffen. Spezielle Elastomer-Dichtungen sorgen für sichere und schnelle Montage. Diese 3-lippigen Dichtungen sind beständig gegen alle Öl- und Gaskondensate aus Brennwertfeuerstätten.

**Stopping-Technik:**

Die Stopping-Technik erhöht die Auszugsfestigkeit der Muffenverbindungen bei der Montage. Rohre in 2 m Baulängen der Durchmesser DN80 und 100 sind ab Werk mit dem ATEC-Stopping ausgerüstet.

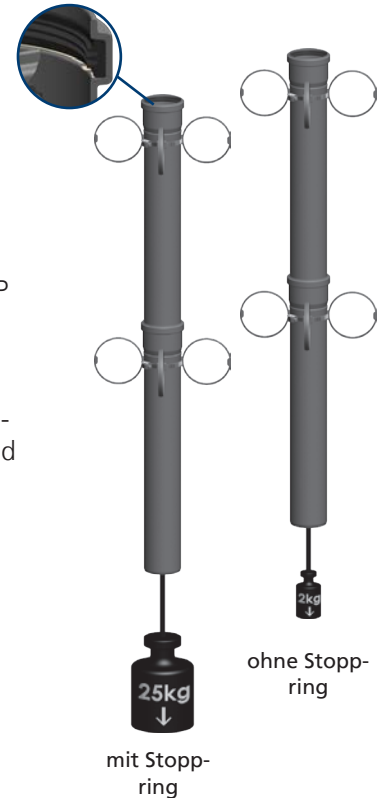

**Klassifizierung und Kennzeichnung**

EN 14471	T120	H1	W	2	O20	LI	E	U
Norm								
max. Abgastemperatur								
	Überdruck bis 5000 Pa = H1							
	Überdruck bis 1500 Pa = M1							
	Überdruck bis 200 Pa = P1							
	feuchte Betriebsweise							
	Korrosionswiderstandsklasse Gas + Heizöl bis 0,2% Schwefelgehalt							
	Bauteile einwandig Abstand zu brennbaren Baustoffen = 20 mm							
	Bauteile doppelwandig Abstand zu brennbaren Baustoffen = 0 mm							
	Einbau der Abgasanlage im Schacht oder Schutzrohr = LI							
	Einbau der Abgasanlage in/oder außerhalb des Gebäudes = LE							
						schlechtes Brennverhalten		
							Konstruktion ohne Ummantellung = U	
							Konstruktion mit brennbarer Ummantellung = U1	
							Konstruktion mit nicht brennbarer Ummantellung = U0	

# EINWANDIGE

**ATEC | ABGASSYSTEME**

## SV-SCHACHT-SETS

### PolyTop

#### SV-Schacht-Set

- (1) SV-Bogen
- (2a) Adapter Stützrohr universell (verlängerbar mit Rohr DN80)
- (2b) SV-Auflager (⚠ nur für DN60 und DN80)
- (3) Schraubstützen kürzbar, 1000 mm
- (4) Abstandhalter 4x für VA-Sanierung
- (5) Mündungs-Set Kunststoff inkl. Befestigung

<b>DN 60</b>	<b>0373</b> €154
<b>DN 80</b>	<b>1373</b> €187
<b>DN 100</b>	<b>2373</b> €269
<b>DN 110</b>	<b>3373</b> €302

Mit dem SV-Schacht-Set kann die vorhandene Edelstahl-Abgasanlage einfach und ohne Öffnen saniert und damit nachhaltig wiederverwendet werden.

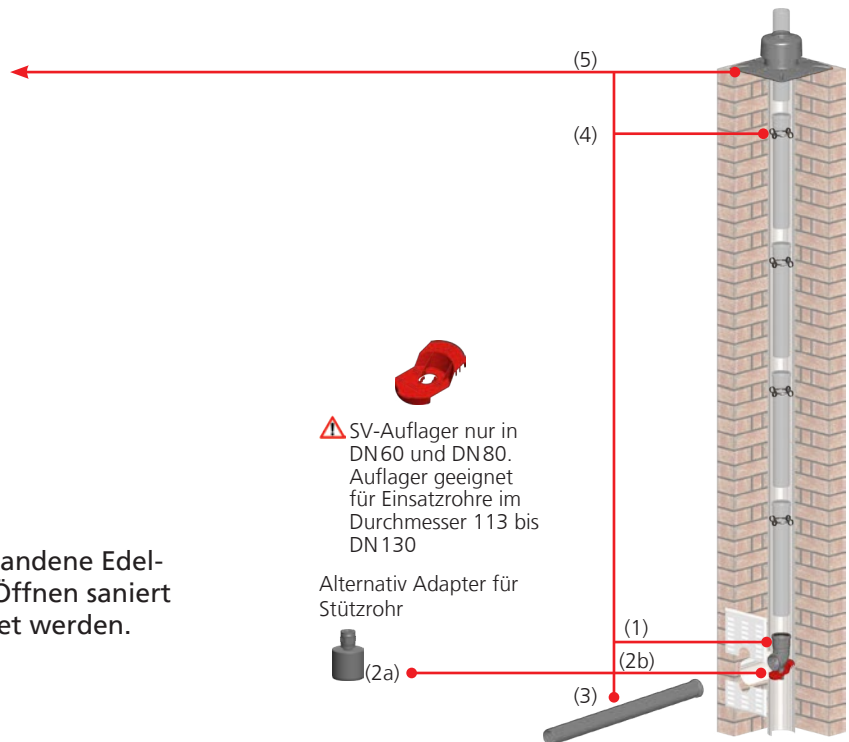

## ERWEITERUNGSOPTIONEN AUßENWAND

	DN 60	DN 80	DN 100	DN 110
<b>Regenabweiser Edelstahl, 100 mm</b>	<b>990080</b> €42	<b>990081</b> €42	<b>990082</b> €45	<b>990083</b> €46
<b>Regenabweiser Edelstahl, 150 mm</b>	<b>990090</b> €54	<b>990091</b> €54	<b>990092</b> €62	<b>990093</b> €69
<b>Zentrierung Endrohr DW-Schornstein</b>	<b>990140</b> €115	<b>990141</b> €118	<b>990142</b> €127	<b>990143</b> €133
<b>Endrohr Edelstahl, 450 mm</b>	<b>990111</b> €53	<b>990102</b> €54	<b>990103</b> €55	<b>990112</b> €57

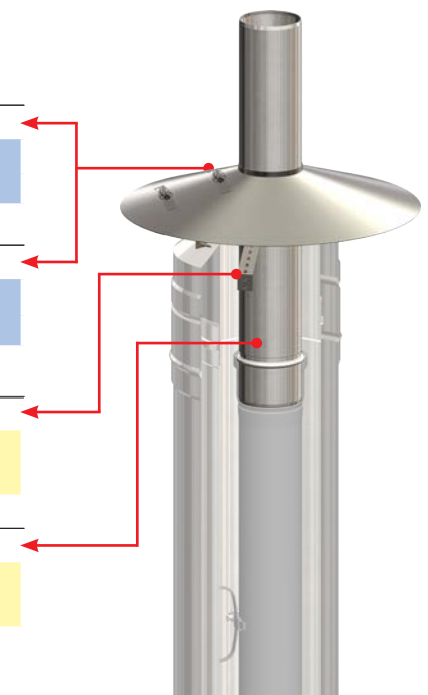

Ergänzt man das obige SV-Schacht-Set um die universelle Endrohr-Zentrierung und den Regenabweiser, so kann einfach und nachhaltig eine vorhandene Edelstahl-Außenwand-Abgasanlage saniert werden. Aus optischen Gründen kann alternativ auch ein Edelstahl-Endrohr verbaut werden.

# EINWANDIGE

**ATEC | ABGASSYSTEME**

**Schacht-Set inkl. Verbindungsleitung**

- (1) Zuluftgitter
- (2) 87°-Kontroll-Bogen
- (3) Rohr 500 mm
- (4) Wandblende mit Hinterlüftung
- (5) Schachteinführung mit Auflager
- (6) Abstandhalter 4x
- (7) Mündungs-Set Kunststoff inkl. Befestigung

**PolyTop** PP-Abgassystem

D 60 - DN 60	<b>0370</b> € 197
D 80 - DN 80	<b>1370</b> € 250
D 100 - DN 100	<b>2372</b> € 346
D 110 - DN 110	<b>3370</b> € 395

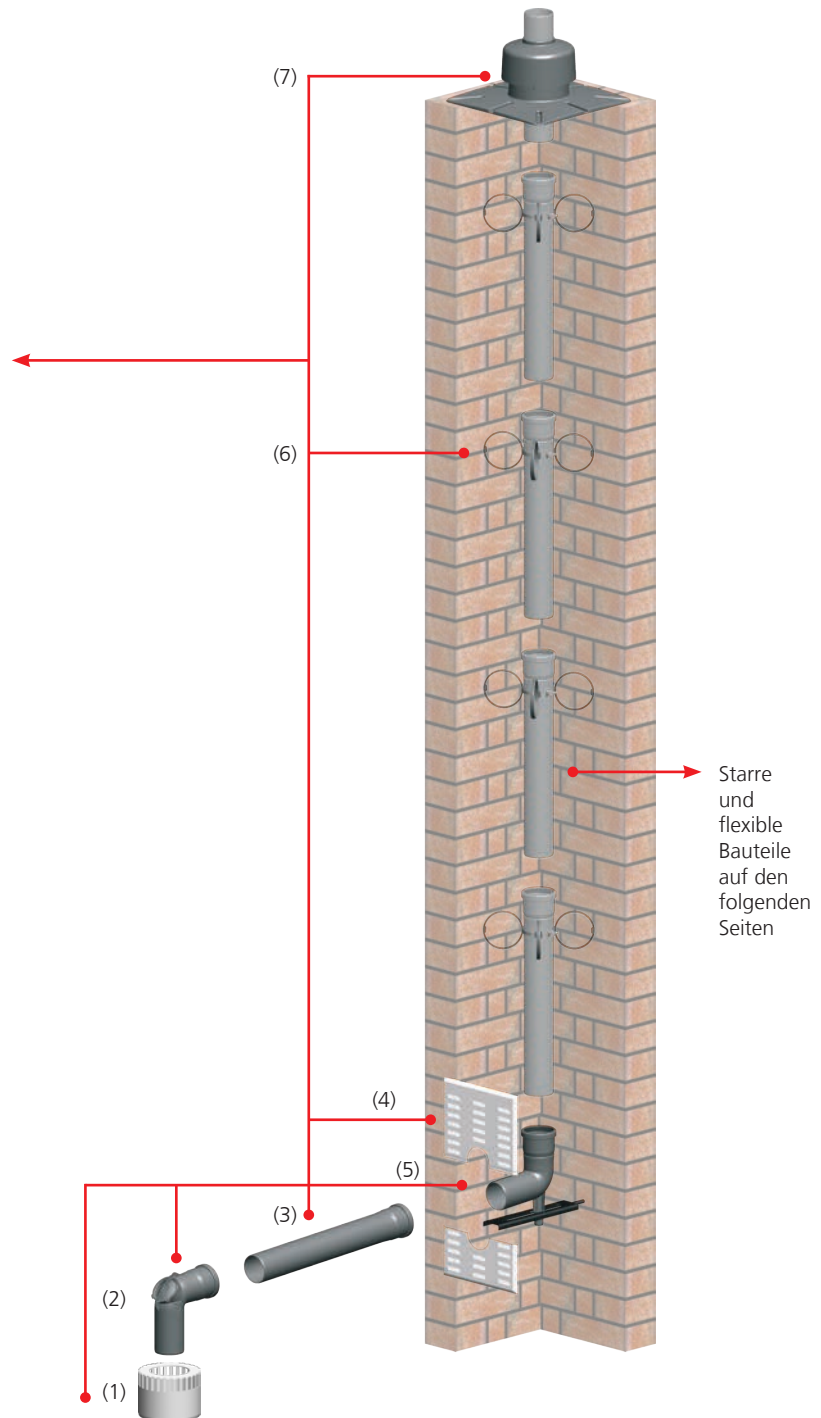



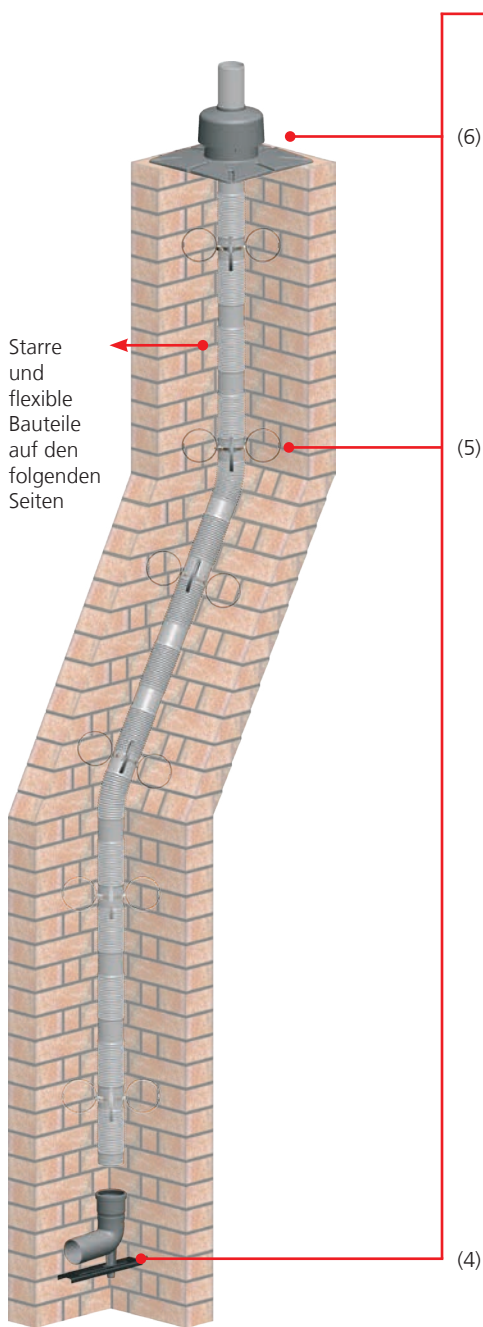

**Schacht-Set mit Mündung aus Kunststoff**  
(4) Schachteinführung mit Auflager  
(5) Abstandhalter 4x  
(6) Mündungs-Set Kunststoff inkl. Befestigung

PolyTop	PP-Abgassystem
D 60 - DN 60	<b>0371</b> €123
D 60 - DN 80	<b>0372</b> €135
D 80 - DN 80	<b>1371</b> €171
D 80 - DN 100	<b>1372</b> €201
D 100 - DN 100	<b>2371</b> €212
D 110 - DN 110	<b>3371</b> €281
D 125 - DN 125	<b>4371</b> €341
D 160 - DN 160	<b>6371</b> €404

Mündungs-Set  
Edelstahl siehe  
Seite 12

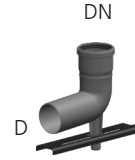

**Schacht-Set mit Mündung aus Kunststoff**  
(4) 87°-Bogen mit Schachteinführungsstütze ohne Auflager  
(5) Abstandhalter 4x  
(6) Mündungs-Set Kunststoff inkl. Befestigung

PolyTop	PP-Abgassystem
D 200 - DN 200	<b>8371</b> €488
D 250 - DN 250	<b>9371</b> €944

Mündungs-Set  
Edelstahl siehe  
Seite 12

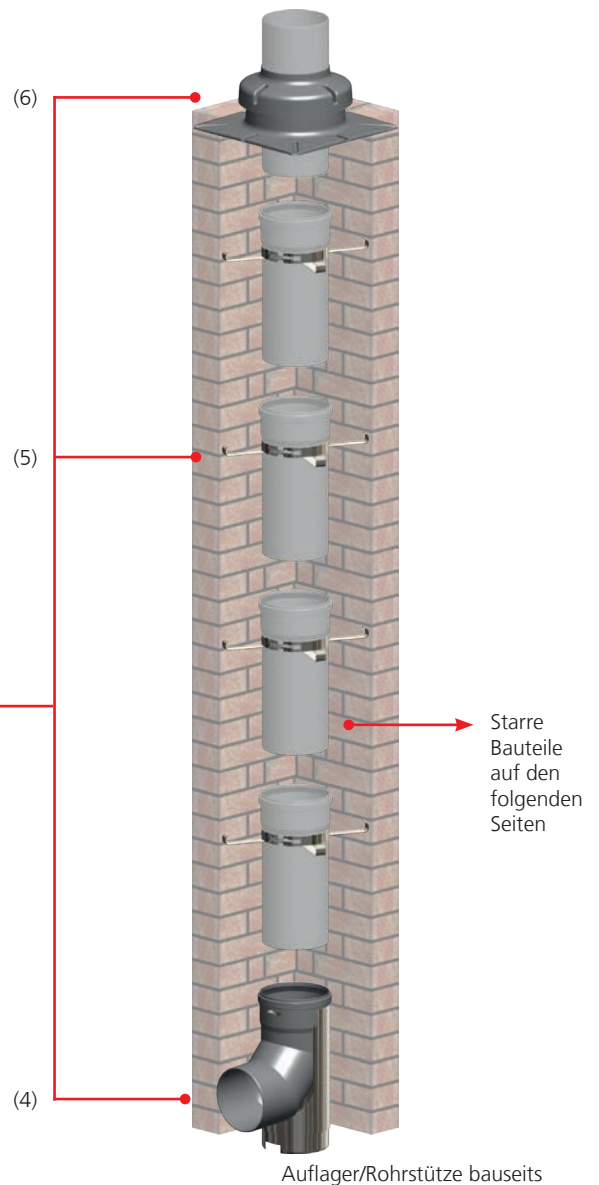

DN 60    DN 80    DN 100    DN 110    DN 125    DN 160    DN 200    DN 250

**SV-Schachteinführung, schraubbar mit Auflager** (für kleine Schächte)



<b>0347</b> €73	<b>1347</b> €77	<b>2347</b> €110	<b>3347</b> €127
--------------------	--------------------	---------------------	---------------------



[Link zum Video](#)

**SV-Auflager für Edelstahl Rohr 113-130mm (5 Stück)**



<b>1383</b> €74
--------------------

**Schachteinführung mit Auflager**

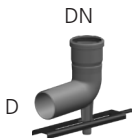

DN	D = DN	<b>0334</b> €40	<b>1334</b> €63	<b>2334</b> €85	<b>3334</b> €110	<b>4334</b> €123	<b>6334</b> €155	<b>8334</b> €174	<b>9334</b> €352
D			<b>0336</b> €53	<b>1336</b> €72					
			D 60	D 80					



Ab DN 200 mit Schachteinführungsstütze (ohne Auflager).

**87°-Kontroll-Bogen**



<b>0301</b> €26	<b>1301</b> €35	<b>2301</b> €49	<b>3301</b> €95	<b>4301</b> €118	<b>6301</b> €133	<b>8301</b> €155	<b>9301</b> €300
--------------------	--------------------	--------------------	--------------------	---------------------	---------------------	---------------------	---------------------

**Kontroll-Rohr**



	<b>0303</b> €26	<b>1303</b> €32	<b>2303</b> €43	<b>3303</b> €59	<b>4303</b> €86	<b>6303</b> €118	<b>8303</b> €123	<b>9303</b> €268
Nutzlänge	147 mm	190 mm	210 mm	230 mm	215 mm	261 mm	366 mm	434 mm

**30°-Bogen**



<b>0314</b> €14	<b>1314</b> €18	<b>2314</b> €24	<b>3314</b> €39	<b>4314</b> €44	<b>6314</b> €85	<b>8314</b> €123	<b>9314</b> €187
--------------------	--------------------	--------------------	--------------------	--------------------	--------------------	---------------------	---------------------

**45°-Bogen**



<b>0315</b> €14	<b>1315</b> €18	<b>2315</b> €24	<b>3315</b> €39	<b>4315</b> €44	<b>6315</b> €85	<b>8315</b> €123	<b>9315</b> €205
--------------------	--------------------	--------------------	--------------------	--------------------	--------------------	---------------------	---------------------

**87°-Bogen**



<b>0316</b> €17	<b>1316</b> €20	<b>2316</b> €29	<b>3316</b> €41	<b>4316</b> €47	<b>6316</b> €85	<b>8316</b> €142	<b>9316</b> €268
--------------------	--------------------	--------------------	--------------------	--------------------	--------------------	---------------------	---------------------

**Rohr, kürzbar**



Nutzlänge	255 mm	<b>0317</b> €13	<b>1317</b> €13	<b>2317</b> €20	<b>3317</b> €22	<b>4317</b> €25	<b>6317</b> €39		
	360 mm							<b>8317</b> €47	<b>9317</b> €103
	500 mm	<b>0318</b> €14	<b>1318</b> €20	<b>2318</b> €26	<b>3318</b> €28	<b>4318</b> €35	<b>6318</b> €47	<b>8318</b> €79	<b>9318</b> €123
	955 mm	<b>0319</b> €18	<b>1319</b> €26	<b>2319</b> €33	<b>3319</b> €49	<b>4319</b> €51	<b>6319</b> €70	<b>8319</b> €101	<b>9319</b> €187
	1.955 mm	<b>0320</b> €28	<b>1320</b> €41	<b>2320</b> €54	<b>3320</b> €74	<b>4320</b> €82	<b>6320</b> €108	<b>8320</b> €174	<b>9320</b> €269

**Langmuffe**



	<b>0324</b> €26	<b>1324</b> €29	<b>2324</b> €38	<b>3324</b> €44
Nutzlänge	80 - 190 mm			

	DN 60	DN 80	DN 100	DN 110	DN 125	DN 160	DN 200	DN 250
--	-------	-------	--------	--------	--------	--------	--------	--------

**Kondensatablauf mit Siphon, bis 1000 Pa Überdruck geeignet**



	<b>0348</b> €54	<b>1348</b> €53	<b>2348</b> €64	<b>3348</b> €90	<b>4348</b> €90	<b>6348</b> €123	<b>8348</b> €155	<b>9348</b> €236
Nutzlänge	137 mm	137 mm	137 mm	137 mm	161 mm	131 mm	199 mm	395 mm
Für höhere Drücke anderer Siphon auf Anfrage								

**87°-Siphonanschluss für Kondensatablauf**



**601349**  
€21

**Messelement/Kesselanschluss**



	<b>0115</b> €35	<b>1115</b> €33	<b>2115</b> €44	<b>3115</b> €56	<b>4115</b> €60	<b>6115</b> €75	<b>8115</b> €77	<b>9115</b> €110
--	--------------------	--------------------	--------------------	--------------------	--------------------	--------------------	--------------------	---------------------

**Flexrohr-Set bestehend aus:**

Anzahl Montage-Set: ( )



10 m	<b>10322 (1)</b> €279	<b>11322 (1)</b> €400	<b>12322 (1)</b> €609					
12,5 m	<b>20322 (1)</b> €354	<b>21322 (1)</b> €512	<b>22322 (1)</b> €759					
15 m	<b>30322 (1)</b> €421	<b>31322 (1)</b> €613	<b>32322 (1)</b> €906	<b>33322 (1)</b> €906	<b>34322 (1)</b> €1160	<b>36322 (1)</b> €1606		
20 m				<b>53322 (1)</b> €1186	<b>54322 (1)</b> €1549	<b>56322 (1)</b> €2142		

75 m	<b>90322 (6)</b> €1717	<b>91322 (5)</b> €1655	<b>92322 (3)</b> €2760	<b>83322 (0)</b> €1972	<b>84322 (0)</b> €2323	<b>86322 (0)</b> €3213		
------	---------------------------	---------------------------	---------------------------	---------------------------	---------------------------	---------------------------	--	--

← Ohne Montageset.

**Montage-Set für Rohr flexibel bestehend aus:**

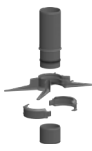

Mündungsendstück  
Aufhängung  
Fixschellen  
Hülse

	<b>0327</b> €50	<b>1327</b> €50	<b>2327</b> €50	<b>3327</b> €64	<b>4327</b> €155	<b>6327</b> €187
--	--------------------	--------------------	--------------------	--------------------	---------------------	---------------------

**Rohr flexibel, Sonderlänge per m; Lieferzeit 1 - 4 Tage**



	<b>0322</b> €33	<b>1322</b> €49	<b>2322</b> €60	<b>3322</b> €60	<b>4322</b> €77	<b>6322</b> €105
--	--------------------	--------------------	--------------------	--------------------	--------------------	---------------------



Je Sonderlänge wird ein Montage-Set benötigt.



Von DN 125 und DN 160 müssen mindestens 12 m bestellt werden.

**Einzugshilfe für Rohr flexibel**



	<b>0382</b> €53	<b>1382</b> €55	<b>2382</b> €58	<b>3382</b> €69
--	--------------------	--------------------	--------------------	--------------------

**Kupplung für Rohr flexibel und starres Rohr (bei Edelstahl Mündungs-Set oder zur Verbindung von flexiblen Leitungsabschnitten erforderlich)**



	<b>0351</b> €54	<b>1351</b> €82	<b>2351</b> €111	<b>3351</b> €111	<b>4351</b> €131	<b>6351</b> €154
--	--------------------	--------------------	---------------------	---------------------	---------------------	---------------------

**Kontroll-Rohr für Rohr flexibel (mit Stockanker)**















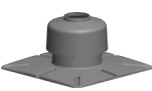

	<b>0304</b> €86	<b>1304</b> €127	<b>2304</b> €153
Nutzlänge	81mm	117 mm	139 mm

**Kontroll-Rohr für Rohr flexibel (inklusive Befestigungsset)**



	<b>3304</b> €171	<b>4304</b> €235	<b>6304</b> €267
Nutzlänge	172 mm	156 mm	170 mm

	DN 60	DN 80	DN 100	DN 110	DN 125	DN 160	DN 200	DN 250
<b>Abstandhalter</b> 	Preis für 4 Stück				ab DN 125 Preis per Stück			
	0354 €38	1354 €49	2354 €51	3354 €52	6352 €24	8352 €32	9352 €43	
	ab DN 200 aus Edelstahl							
<b>Abstandhalter für *große Schächte</b> 	0353 €52	1353 €54	2353 €88	3353 €60	4353 €62	6353 €63	8353 €72	9353 €76
* max.lichte Weite in mm	580	580	600	600	620	650	700	750
<b>Abstandhalter Stern (10 Stück)</b> 	0357 €90	1357 €96		3357 €105				
 Nur für starre Rohre.								
<b>Kleine Abstandhalter für VA Sanierung (4 Stück)</b> 	1358 €52							
<b>Mündungs-Set Kunststoff (inkl Befestigungs-Set)</b> 	360 x 360 mm	0338 €59	1338 €89	2338 €104	3338 €122			
	400 x 400 mm				4338 €131	6338 €163		
	440 x 440 mm						8338 €212	
	500 x 500 mm							9338 €277
<b>Mündungs-Set Edelstahl mit Endrohr 450 mm</b> , erforderlich bei neben angeordneten und in Betrieb befindlichen Festbrennstoffzügen! 	330 x 330 mm	0342 €198	1342 €232	2342 €269	3342 €292			
 Kupplung (siehe Seite 11) bei Rohr flexibel notwendig.								
<b>Zuluftverschluss Edelstahl</b> , passend für Mündungs-Set Edelstahl 	305 x 305 mm	990049 €64	990050 €64	990051 €64	990052 €64			
<b>Mündungs-Set Edelstahl</b> 	400 x 400 mm					4342 €198	6342 €226	8342 €277
 Kupplung (siehe Seite 11) bei Rohr flexibel notwendig.								
	ab DN 200 440 x 440 mm							
<b>Endrohr Edelstahl</b> , erforderlich bei neben angeordneten und in Betrieb befindlichen Festbrennstoffzügen! 	450 mm	990111 €53	990102 €54	990103 €55	990112 €57	4344 €83	Festbrennstoffzugerhöhungen siehe Seite 20	
	940 mm	990117 €83	990028 €84	990029 €87	990045 €98		6344 €117	8344 €133
							9344 €151	
<b>Wandblende mit Hinterlüftung für raumluftabhängigen Betrieb</b> 	280 x 350 mm	0330 €46	1330 €61	2330 €61				
<b>Wandblende mit Hinterlüftung für raumluftabhängigen Betrieb</b> 	280 x 340 mm				3330 €59	4330 €61	6330 €67	
	350 x 350 mm						8330 €100	9330 €122
<b>Zuluftgitter</b> DN  D		0590 €30	1590 €36	2590 €41	3590 €47			
		D100	D125	D150	D160			

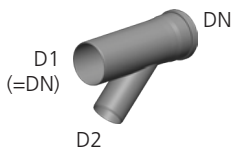
	DN 60	DN 80	DN 100	DN 110	DN 125	DN 160	DN 200	DN 250
<b>Abzweig 42°</b>								
				603308 €103	604319 €109			
D2 60								
D2 80	601316 €89	602316 €103	603316 €103	604316 €123	606318 €154	608318 €214		
D2 100			602317 €116	603317 €116	604317 €116	606317 €194	608317 €214	609318 €227
D2 110				603322 €121	604318 €129	606319 €195	608321 €231	609321 €263
D2 125					604312 €159	606320 €195	608316 €250	609316 €293
D2 160						606322 €224	608319 €289	609317 €322
D2 200							608322 €344	609319 €325
D2 250								609320 €386

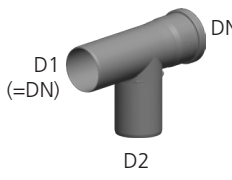
	DN 60	DN 80	DN 100	DN 110	DN 125	DN 160	DN 200	DN 250
<b>T-Stück</b>								
								
D2 60	600303 €50	601301 €73	602301 €62		604301 €101	606301 €122		
D2 80		601303 €50	602302 €62	603305 €97	604304 €121	606303 €123	608301 €159	
D2 100			602303 €55		604305 €126	606308 €159	608302 €159	
D2 110				603303 €115	604309 €134	606312 €129	608311 €235	
D2 125					604303 €134	606321 €160	608304 €143	609303 €269
D2 160						606310 €156	608309 €168	609304 €269
D2 200							608310 €267	609305 €289
D2 250								609310 €321

 Weitere Ausführungen auf Anfrage.

**Hosenformteil** Lieferzeit 2 - 4 Tage

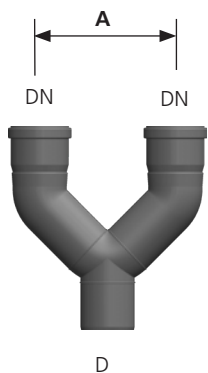

Achsabstand **A**= ..... mm



**Maß A muss bei der Bestellung angegeben werden!**

Bei Bestellung von Hosenformteilen wird der Achsabstand (A) der beiden Schächte (Mitte/Mitte) benötigt. Bereits bei der Planung muss die Abstimmung mit dem bevollmächtigten Bezirksschornsteinfeger erfolgen. Weitere Ausführungen auf Anfrage.



		DN 60	DN 80	DN 100	DN 110			DN 125	DN 160	DN 200	DN 250
<b>Reduktion/Erweiterung zentrisch</b>											
 DN D	D 60		<b>1137</b> €35		<b>3103</b> €129			<b>4105</b> €124			
	D 63		<b>1138</b> €35					<b>4108</b> €124	<b>6105</b> €122		
	D 70		<b>1139</b> €35					<b>4112</b> €124			
	D 75	<b>0140</b> €65	<b>1140</b> €35	<b>1143</b> €47					<b>6111</b> €124		
	D 80	<b>0130</b> €32		<b>1146</b> €43	<b>3150</b> €61			<b>4106</b> €124	<b>6114</b> €159		
	D 100		<b>1141</b> €38		<b>3151</b> €59			<b>4101</b> €118	<b>6117</b> €154		
	D 110		<b>1142</b> €43	<b>2232</b> €51				<b>4104</b> €118			
	D 125			<b>2102</b> €77	<b>3101</b> €77			<b>4111</b> €188	<b>6102</b> €150		
	D 150			<b>2101</b> €142	<b>3104</b> €150			<b>4113</b> €161	<b>6103</b> €155		<b>9106</b> €270
	D 160				<b>3105</b> €97				<b>6112</b> €155	<b>8102</b> €155	
D 200				<b>3106</b> €189							

 Weitere Übergänge in Vorbereitung/auf Anfrage.

<b>Reduktion/Erweiterung exzentrisch</b>											
 DN D	D 60		<b>1157</b> €40	<b>2104</b> €70				<b>4109</b> €77	<b>6116</b> €144		
	D 63		<b>1158</b> €40					<b>4102</b> €77	<b>6107</b> €142		
	D 70		<b>1159</b> €40					<b>4103</b> €77	<b>6113</b> €122	<b>8109</b> €122	
	D 75		<b>1160</b> €47						<b>6104</b> €122	<b>8108</b> €122	<b>9108</b> €179
	D 80			<b>1166</b> €55	<b>3102</b> €82				<b>6106</b> €142		
	D 100				<b>1168</b> €82				<b>6101</b> €133		
	D 110		<b>1162</b> €38							<b>8107</b> €142	<b>9102</b> €186
	D 125									<b>8103</b> €155	
D 160								<b>6118</b> €155		<b>9101</b> €187	
D 180										<b>9107</b> €308	
D 200											
D 250											
D 300											

 Weitere Übergänge in Vorbereitung/auf Anfrage.

**Vario-Stopfen für Emissionsmessung**



Ø 11 mm

**169921**  
€7

**Gleitmittel 150 g Tube**



**160000**  
€10

**Kondensatbox für Gas-Brennwert, inklusive Füllung**



bis 30 kW

**601129**  
€144



bis 35 kW

**601285**  
€285

bis 65 kW

**601286**  
€334



bis 150 kW

**601287**  
€477

bis 300 kW

**601288**  
€635

**Kondensatbox für Öl-Brennwert, inklusive Füllung**



bis 30 kW

**601129**  
€144



bis 35 kW

**601292**  
€495

bis 50 kW\*

\* bei schwefelarmen Öl

**Nachfüllgranulat zu 601129**



1,4 kg

**169964**  
€20

**Nachfüllgranulat zu 601285 bis 601292**



2 x 1,3 kg

**601296**  
€70

5 kg

**601297**  
€122

Aktivkohle

2 x 250 g

**601298**  
€84

**Einzughilfe Flexrohr für SV Schachtverschraubung bis DN110**



**601382**  
€26

**Adapter Stützrohr**



**601483**  
€36

**Wasserwaage**

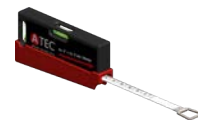

**1050068**  
€30

DN 60    DN 80    DN 100    DN 110    DN 125    DN 160    DN 200    DN 250

**3-fach Lippendichtung**



**160380**  
€5

**161380**  
€6

**162380**  
€9

**163380**  
€9

**164380**  
€12

**166380**  
€15

**168380**  
€17

**169380**  
€20

**Haubentop für Dachhochführung als Ersatzteil**



ziegelrot

**160366**  
€24

**161366**  
€25

schwarz

**160365**  
€24

**161365**  
€25

**Mündungshaube für Abdeckplatte als Ersatzteil**

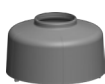

schwarz

**160364**  
€25

**161364**  
€26

**162364**  
€30

**163364**  
€43

**Dichtung für Kontroll-Bauteile**



**160381**  
€6

**161381**  
€6

**162381**  
€6

**163381**  
€5

**166381**  
€8

**168381**  
€13

**169381**  
€20

# KONZENTRISCHE

## ATEC | ABGASSYSTEME

### Schacht-Set inkl. Verbindungsleitung mit Mündung aus Kunststoff und SV-Schachteinführung

- (1) 87°-Kontroll-Bogen
- (2) Rohr 500 mm
- (3) Wandblende geschlossen
- (4) SV-Schachteinführung mit Auflager
- (5) Abstandhalter 4x
- (6) Mündungs-Set Kunststoff 360 x 360 mm inkl. Befestigung

#### **PolyClassic** PP-Abgassystem/Stahl weiß

DN 80/125 - DN 80 **1473**  
€384

#### **PolyTwin** PP-Abgassystem/PP-weiß

DN 60/100 - DN 60 **0573**  
€281

DN 80/125 - DN 80 **1573**  
€382

### Ihr Kostensenker, nur Original von ATEC

Die SV-Schachteinführung reduziert ihre Stemmarbeit, Maurer- und Verputzarbeit, erspart Ihnen ggf. den Ausbau von Sanierungsrohren und mindert oder verhindert die Einsturzgefahr von Innenschalen mehrschaliger Schornsteinsysteme. Eine Kernbohrung reicht.

Wenn die Höhe stimmt, montieren Sie durch den alten Rauchrohranschluss.

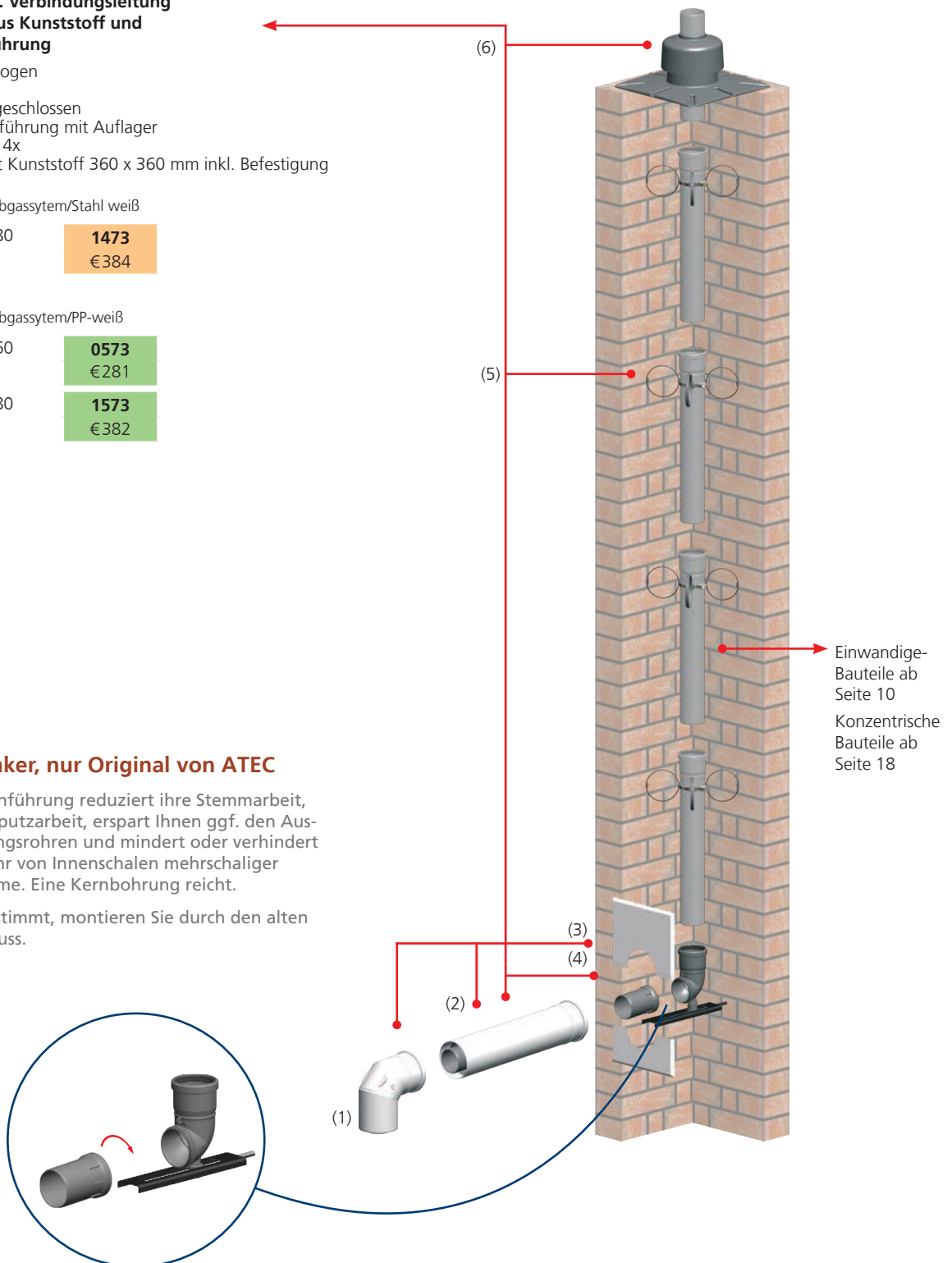



## Schacht-Set inkl. Verbindungsleitung mit Mündung aus Kunststoff

- (1) 87°-Kontroll-Bogen
- (2) Rohr 500 mm
- (3) Wandblende geschlossen
- (4) Schachteinführung mit Auflager
- (5) Abstandhalter 4x
- (6) Mündungs-Set Kunststoff 360 x 360 mm inkl. Befestigung

### PolyClassic PP-Abgassystem/Stahl weiß

DN 80/125 - DN 80	<b>1470</b> €330
DN 100/150 - DN 100	<b>2480</b> €540

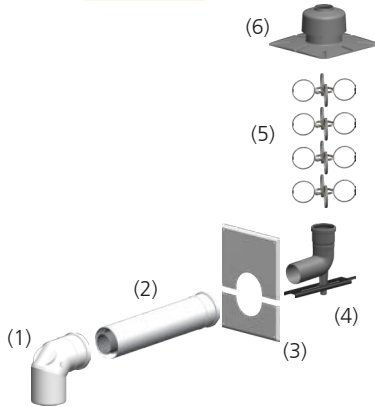

### PolyTwin PP-Abgassystem/PP-weiß

DN 60/100 - DN 60	<b>0570</b> €222
DN 60/100 - DN 80	<b>0580</b> €281
DN 80/125 - DN 80	<b>1570</b> €327
DN 110/160 - DN 110	<b>3570</b> €526

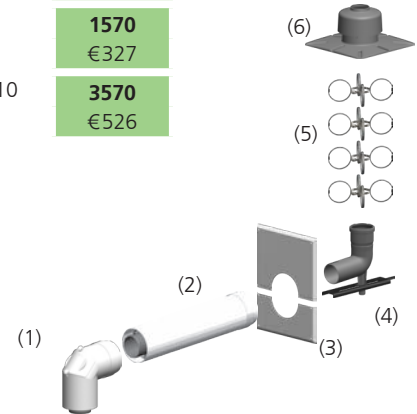

## Schacht-Set inkl. Verbindungsleitung mit Mündung aus Edelstahl

- (1) 87°-Kontroll-Bogen
- (2) Rohr 500 mm
- (3) Wandblende geschlossen
- (4) Schachteinführung mit Auflager
- (5) Abstandhalter 4x
- (6) Mündungs-Set Edelstahl 330 x 330 mm inkl. Befestigung

### PolyClassic PP-Abgassystem/Stahl weiß

DN 80/125 - DN 80	<b>1471</b> €474
-------------------	---------------------

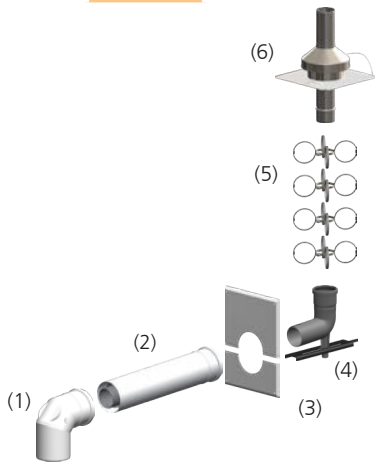

### PolyTwin PP-Abgassystem/PP-weiß

DN 60/100 - DN 60	<b>0571</b> €369
DN 60/100 - DN 80	<b>0581</b> €413
DN 80/125 - DN 80	<b>1571</b> €470

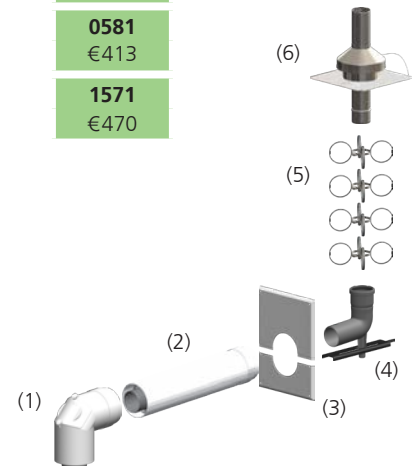

**!** Bei Montagen mit flexiblem Rohr ist zusätzlich eine Kupplung (siehe Seite 11) notwendig.

KONZENTRISCH

**87°-Kontroll-Bogen, konzentrisch**

DN 80/125	<b>1401</b> €131	
DN 100/150	<b>2401</b> €218	

**Kontroll-Rohr, konzentrisch**

DN 80/125	<b>1403</b> €115	
DN 100/150	<b>2403</b> €197	

**30°-Bogen, konzentrisch**

DN 80/125	<b>1414</b> €58	
DN 100/150	<b>2414</b> €124	

**45°-Bogen, konzentrisch**

DN 80/125	<b>1415</b> €59	
DN 100/150	<b>2415</b> €108	

**87°-Bogen, konzentrisch**

DN 80/125	<b>1416</b> €83	
DN 100/150	<b>2416</b> €108	

**Rohr, konzentrisch, kürzbar**

DN 80/125	<b>1417</b> €52		Nutzlänge 255 mm
DN 100/150	<b>2417</b> €81		
DN 80/125	<b>1418</b> €61		500 mm
DN 100/150	<b>2418</b> €98		
DN 80/125	<b>1419</b> €90		955 mm
DN 100/150	<b>2419</b> €132		
DN 80/125	<b>1420</b> €165		1.955 mm

**Kondensatablauf, konzentrisch mit Siphon**

DN 80/125	<b>1448</b> €83	
DN 100/150	<b>2448</b> €127	

 Mit 87°-Siphonanschluss auf Seite 12 als senkrechter Kondensatablauf einsetzbar.

**Schiebeelement**

DN 80/125	<b>1424</b> €123		Nutzlänge 280 - 420 mm
DN 100/150	<b>2424</b> €156		280 - 420 mm

**Schachteinführung, konzentrisch**

DN 80/125	<b>1434</b> €132	
DN 100/150	<b>2434</b> €218	

**87°-Kontroll-Bogen mit seitlichen Messöffnungen für Zu-  
luft/Abgas**

DN 80/125	<b>1219</b> €161	
-----------	---------------------	---

**Kesselanschluss mit Messöffnung, gerade**

DN 80/125	<b>1220</b> €67	
DN 100/150	<b>2220</b> €100	

**Zuluftansaug-Set für Kontroll-Bauteile**

DN 80/125	<b>1478</b> €61	
DN 100/150	<b>2478</b> €78	

**T-Stück für Kaskade**

DN 80/125	<b>1404</b> €189	
DN 100/150	<b>2404</b> €233	

**87°-Kontroll-Bogen, konzentrisch**

DN 60/100	<b>0501</b> €93
DN 80/125	<b>1501</b> €125
DN 110/160	<b>3501</b> €191



**Kontroll-Rohr, konzentrisch**

DN 60/100	<b>0503</b> €78
DN 80/125	<b>1503</b> €112
DN 110/160	<b>3503</b> €177



**30°-Bogen, konzentrisch**

DN 60/100	<b>0514</b> €45
DN 80/125	<b>1514</b> €55
DN 110/160	<b>3514</b> €95



**45°-Bogen, konzentrisch**

DN 60/100	<b>0515</b> €45
DN 80/125	<b>1515</b> €56
DN 110/160	<b>3515</b> €95



**87°-Bogen, konzentrisch**

DN 60/100	<b>0516</b> €61
DN 80/125	<b>1516</b> €81
DN 110/160	<b>3516</b> €105



**Rohr, konzentrisch, kürzbar**

DN 60/100	<b>0517</b> €33
DN 80/125	<b>1517</b> €49
DN 110/160	<b>3517</b> €72
DN 60/100	<b>0518</b> €44
DN 80/125	<b>1518</b> €59
DN 110/160	<b>3518</b> €87
DN 60/100	<b>0519</b> €57
DN 80/125	<b>1519</b> €86
DN 110/160	<b>3519</b> €117
DN 60/100	<b>0520</b> €112
DN 80/125	<b>1520</b> €157



Nutzlänge 255 mm

500 mm

955 mm

1.955 mm

**Kondensatablauf, konzentrisch mit Siphon**

DN 60/100	<b>0548</b> €73
DN 80/125	<b>1548</b> €81
DN 110/160	<b>3548</b> €95



 Mit 87°-Siphonanschluss auf Seite 12 als senkrechter Kondensatablauf einsetzbar.

**Schachteinführung, konzentrisch**

DN 60/100	<b>0534</b> €103
DN 80/125	<b>1534</b> €135
DN 110/160	<b>3534</b> €192



**87°-Kontroll-Bogen mit seitlichen Messöffnungen für Zuluft/Abgas**

DN 80/125	<b>1819</b> €155
-----------	---------------------



**Kesselanschluss mit Messöffnung, gerade**

DN 60/100	<b>0820</b> €72
DN 80/125	<b>1820</b> €72
DN 110/160	<b>3820</b> €82



**Zuluftansaug-Set für Kontroll-Bauteile**

DN 60/100	<b>0578</b> €55
DN 80/125	<b>1578</b> €60
DN 110/160	<b>3578</b> €69



**T-Stück für Kaskade**

DN 60/100	<b>0504</b> €159
DN 80/125	<b>1504</b> €178
DN 110/160	<b>3504</b> €180



**Zuluftstutzen**

DN 80/125 D 80	<b>1584</b> €95
DN 110/160 D 100	<b>3584</b> €118



DN 60/100    DN 80/125    DN 100/150    DN 110/160

**Mündungs-Set konzentrisch**

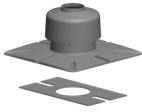

<b>0438</b> €133	<b>1438</b> €155	<b>2438</b> €190	<b>3438</b> €181
---------------------	---------------------	---------------------	---------------------

**Wandblende geschlossen**



280 x 340 mm

<b>0428</b> €44	<b>1428</b> €44	<b>2428</b> €45	<b>3428</b> €48
--------------------	--------------------	--------------------	--------------------

**Kaminabschluss für Unterdach**

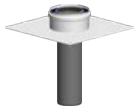

300 x 300 mm

<b>0538</b> €104	<b>1538</b> €102	<b>2538</b> €107	<b>3538</b> €122
---------------------	---------------------	---------------------	---------------------

**Flexrohraufhängung, in Verbindung mit Kaminabschluss und Kupplung für Rohr flexibel**



<b>169012</b> €41	<b>169013</b> €41	<b>169014</b> €42	<b>169015</b> €45
----------------------	----------------------	----------------------	----------------------

Kupplung (siehe Seite 11) bei Rohr flexibel notwendig.

**Außenwandanschluss**



	<b>0480</b> €100	<b>1480</b> €115
Baulänge	851 mm	891 mm

Vor der Montage muss die Zustimmung durch den bevollmächtigten Bezirksschornsteinfeger erfolgen.



**Durchmesser der Erhöhung: F in mm**    Ø 140    Ø 160    Ø 200    Ø 250    Ø 300    Ø 350

**Festbrennstoffzugerhöhung Ziegelschornstein**

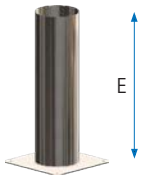

	<b>601401</b> €167	<b>601403</b> €180	<b>601405</b> €223	<b>601406</b> €273	<b>601408</b> €378	<b>601410</b> €421
A x B in mm	250 x 250	250 x 333	250 x 333	333 x 333	500 x 500	500 x 500
C x D in mm	210 x 210	210 x 293	210 x 293	293 x 293	460 x 460	460 x 460
E in mm	500	500	500	500	500	500

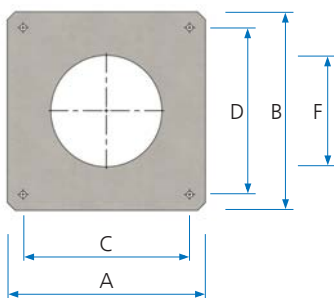

**Regenhaube für Festbrennstoffzugerhöhung**



<b>601430</b> €80	<b>601431</b> €92	<b>601432</b> €96	<b>601433</b> €108	<b>601434</b> €131	<b>601435</b> €171
----------------------	----------------------	----------------------	-----------------------	-----------------------	-----------------------

**87°-Kontroll-Bogen mit seitlichen Messöffnungen für Zu-  
luft/Abgas**

Durchmesser		PolyClassic PP/Stahl weiß	PolyTwin PP/PP weiß	
Eintauch- seite:	Muffen- seite			
80/130	80/125	1201 €173		
80/110	80/125	1217 €161		
universell*	80/125	1219 €161	1819 €155	
80/126	80/125	1271 €180	1871 €155	
80 kurz 125	80/125	1273 €161	1873 €157	

**Kesselanschluss mit Messöffnung, gerade**

Durchmesser		PolyClassic PP/Stahl weiß	PolyTwin PP/PP weiß	
Eintauch- seite:	Muffen- seite			
universell*	60/100		0820 €72	
60/110	80/125	1204 €117		
80/110	80/125	1218 €90		
universell*	80/125	1220 €67	1820 €72	
80/126	80/125	1270 €94		
universell*	100/150	2220 €100		
universell*	110/160		3820 €82	

**Adapter**



Durchmesser		PolyTwin PP/PP weiß	
Eintauch- seite:	Muffen- seite		
Adapter 30 mm	60/100	0801 €24	
Adapter 15 mm	80/125	1884 €20	
Adapter 30 mm	110/160	3884 €25	

**87°-Kontroll-Bogen**

Durchmesser		PolyClassic PP/Stahl weiß	PolyTwin PP/PP weiß	
Eintauch- seite:	Muffen- seite			
70/110	80/125	1205 €161	1805 €145	
63/96	80/125	1223 €173	1823 €145	
60/100	80/125	1267 €173	1869 €142	

**Übergang**

Durchmesser		PolyClassic PP/Stahl weiß	PolyTwin PP/PP weiß	
Eintauch- seite:	Muffen- seite			
Schelle Viessmann	60/100		0805 €31	
Schelle/ Verbinder	60/100		0840 €23	
	80/125		0866 €61	
70/110	80/125	1206 €56		
63/96	80/125	1222 €62		
60/100	80/125	1266 €62	1866 €61	
100/150	80/125	1225 €110		
110/160	80/125		1868 €161	
Schelle/ Verbinder	80/125	1240 €25	1840 €24	
	80/125	2266 €97		
	110/158	2227 €62		
	110/160	2221 €123		
60/100	110/160		3264 €127	
80/125	110/160		3266 €84	
100/150	110/160		3268 €84	
110/150	110/160		2267 €86	

-  Weitere Übergänge in Vorbereitung/auf Anfrage.
-  Alle Übergänge für das System PolyClassic passen auch für PolyTwin.

\* universell: Eintauchseite gleich Muffenseite

DN 60/100    DN 80/125    DN 100/150    DN 110/160

**Dachhochführung, konzentrisch inklusive Befestigungsschelle**

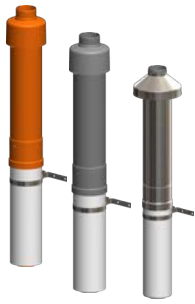

ziegelrot  
650 mm  
schwarz  
650 mm  
Edelstahl  
650 mm  
ziegelrot  
1.100 mm  
schwarz  
1.100 mm

<b>0457</b> € 169	<b>1457</b> € 192		
<b>0458</b> € 169	<b>1458</b> € 192		
	<b>1455</b> € 320		
	<b>1459</b> € 263	<b>2459</b> € 362	<b>3459</b> € 342
	<b>1460</b> € 263	<b>2460</b> € 362	<b>3460</b> € 342

**Verlängerung zur Dachhochführung (kürz- und verlängerbar)**

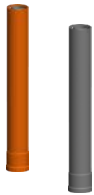

ziegelrot  
955 mm  
schwarz  
955 mm

<b>620457</b> € 119	<b>621457</b> € 135		<b>623457</b> € 281
<b>620458</b> € 119	<b>621458</b> € 135		<b>623458</b> € 281

**Schrägdachpfanne 5° - 45° (unabhängig von der Dacheindeckung)**

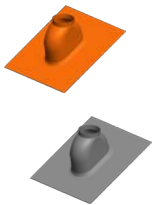

ziegelrot  
470 x 560 mm  
schwarz  
470 x 560 mm  
ziegelrot  
470 x 700 mm  
schwarz  
470 x 700 mm

<b>1555</b> € 126	<b>1555</b> € 126		
<b>1556</b> € 126	<b>1556</b> € 126		
<b>1557</b> € 150	<b>1557</b> € 150	500 x 700 mm	<b>3557</b> € 160
<b>1558</b> € 150	<b>1558</b> € 150	500 x 700 mm	<b>3558</b> € 160

**Schrägdachpfanne 25° - 50° (Universal Dachdurchführung 360 x 395 mm)**

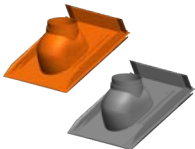

ziegelrot  
schwarz

<b>1467</b> € 126	<b>1467</b> € 126
<b>1468</b> € 126	<b>1468</b> € 126

**Schrägdachpfanne 25° - 45°**

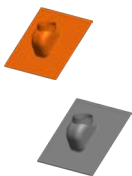

ziegelrot  
450 x 450 mm  
schwarz  
450 x 450 mm  
ziegelrot  
500 x 500 mm  
schwarz  
500 x 500 mm

<b>1561</b> € 85	<b>1561</b> € 85		
<b>1562</b> € 85	<b>1562</b> € 85		
		<b>2461</b> € 113	
		<b>2462</b> € 113	

**Abdeckblende für innen und außen, geteilt, bis 45° Neigung**



Edelstahl weiß beschichtet

<b>0429</b> € 56	<b>1429</b> € 56	<b>2429</b> € 62	<b>3429</b> € 62
---------------------	---------------------	---------------------	---------------------

**Mündungs-Abströmdüse (Windschutzschirm)**

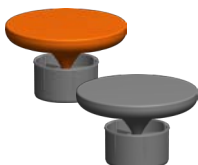

ziegelrot  
schwarz

<b>0461</b> € 54	<b>1461</b> € 57
<b>0462</b> € 54	<b>1462</b> € 57

DN 60/100    DN 80/125    DN 100/150    DN 110/160

## Flachdachkragen



	<b>1466</b> €53	<b>1466</b> €53	<b>2466</b> €82	<b>3466</b> €107
Bauhöhe in mm	150	150	150	150

## Adapter für Klöber-Grundplatten

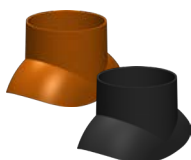

ziegelrot	<b>1247</b> €69	<b>1247</b> €69		
schwarz	<b>1248</b> €69	<b>1248</b> €69		

## Braas Abgaskalotte DuroVent 128



ziegelrot	<b>1257</b> €69	<b>1257</b> €69		
schwarz	<b>1258</b> €69	<b>1258</b> €69		

## Abspannschelle (Spannbänder bauseits)



<b>640459</b> €81	<b>641459</b> €81	<b>642459</b> €109	<b>643459</b> €117
----------------------	----------------------	-----------------------	-----------------------

## Schrägdachpfanne als Sonderanfertigung bis 60°, Lieferzeit ca. 14 Tage

Bei Bestellung muss die Dachneigung angegeben werden.

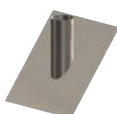

☞ Bleikragen mit Edelstahlstützen

<b>601662</b> €334	<b>601662</b> €334	<b>602662</b> €334	<b>603662</b> €334
-----------------------	-----------------------	-----------------------	-----------------------

## Flexible Flachdachdurchführung bis 20° (inklusive Schrauben und Kleber)

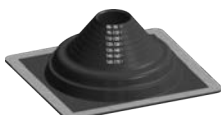

☞ Verwendbar für Blech-, Trapezblech- und Faserzementdächer

	<b>701610</b> €255	<b>702610</b> €255
Grundfläche	270 x 290 mm	375 x 415 mm

## Flachdach-Abgasdurchgang

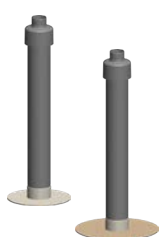

Oberteil PVC	<b>701565</b> €290	<b>703565</b> €507
Oberteil Bitumen-Schweißbahn	<b>701566</b> €299	<b>703566</b> €518
Gesamtlänge	1040 mm	1250 mm

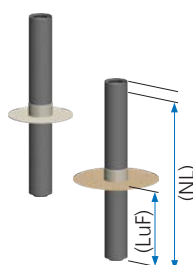

Unterteil PVC	<b>701563</b> €259	<b>703563</b> €451
Unterteil Bitumen-Schweißbahn	<b>701564</b> €267	<b>703564</b> €461
Nutzlänge (NL)	955	958
Länge unter Flansch (LuF)	455	359

☞ Weitere Flachdachdurchführungen bis 20° siehe auch Seite 50

KONZENTRISCH

# AUßENWAND

**ATEC | ABGASSYSTEME**

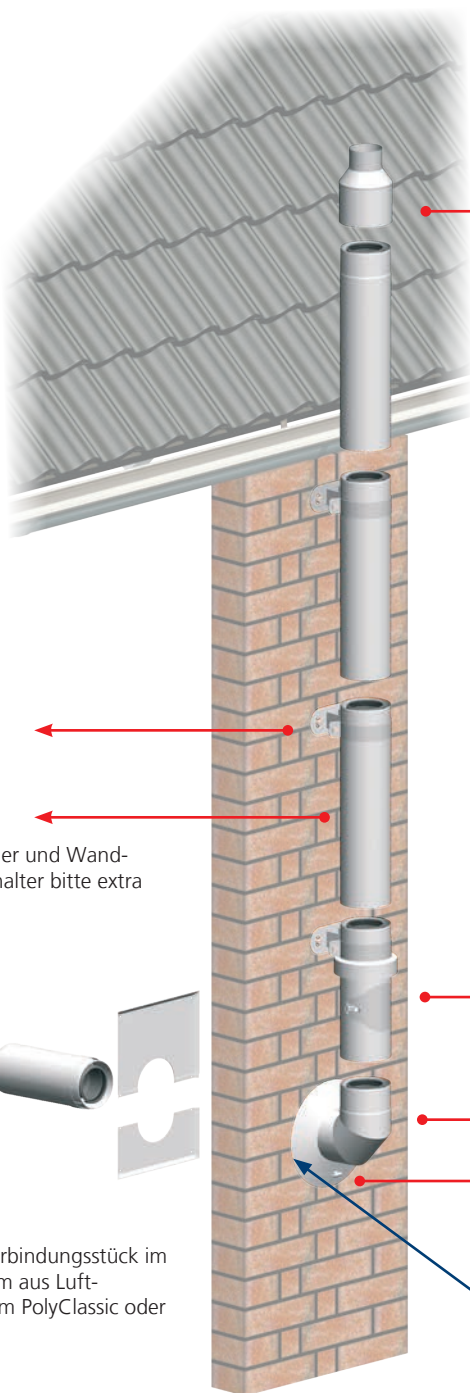

**WhitePoly**  
Bauteile ab  
Seite 25

Querträger und Wand-  
abstandhalter bitte extra  
bestellen

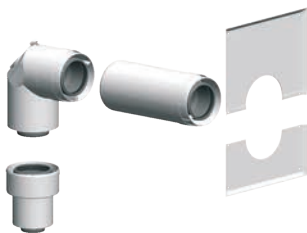

Beispiel: Verbindungsstück im  
Aufstellraum aus Luft-  
Abgassystem PolyClassic oder  
PolyTwin

**DN 60/100 DN 80/125**

**Dachhochführung**

	ziegelrot, 650 mm	
	<b>710757</b> €259	<b>711757</b> €273
	schwarz, 650 mm	
	<b>710758</b> €259	<b>711758</b> €273

Schrägdachpfanne und Flachdachkragen  
siehe Seiten 22, 23 und 31.

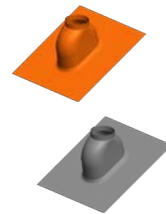

**Basis-Set für die Installation an der Außenwand**

- (1) Wandrosette
  - (2) 87°-Bogen
  - (3) Kontroll-Rohr mit Zuluftansaugung
  - (4) Mündungsabschluss
- WhitePoly** PP/Edelstahl weiß

		Nutzlänge
<b>DN 60/100</b>	<b>710770</b> €386	475 mm
<b>DN 80/125</b>	<b>711770</b> €421	530 mm
<b>DN 100/150</b>	<b>712770</b> €506	575 mm
<b>DN 110/160</b>	<b>713770</b> €572	585 mm

Im Bereich der Wand-  
durchführung ist White/  
IronPoly zu verwenden.



DN 60/100 DN 80/125 DN 100/150 DN 110/160

**Erweiterung, exzentrisch**

	DN	<b>711798</b> €98	<b>712798</b> €137	<b>713798</b> €163
	D	D 60/100	D 80/125	D 80/125

**Reduzierung, zentrisch**

	DN	<b>0866</b> €61	<b>712799</b> €137
	D	D 80/125	D 100/150

**Mündungsabschluss**

		<b>710754</b> €72	<b>711754</b> €72	<b>712754</b> €88	<b>713754</b> €92
	Nutzlänge	145 mm	145 mm	145 mm	145 mm

**Rohrelement, kürzbar**

	Nutzlänge	190 mm			
		<b>710717</b> €69	<b>711717</b> €78	<b>712717</b> €83	<b>713717</b> €100
	Nutzlänge	440 mm			
		<b>710718</b> €81	<b>711718</b> €88	<b>712718</b> €100	<b>713718</b> €119
	Nutzlänge	940 mm			
		<b>710719</b> €93	<b>711719</b> €100	<b>712719</b> €134	<b>713719</b> €166

**Kontroll-Rohr**

		<b>710703</b> €118	<b>711703</b> €134	<b>712703</b> €169	<b>713703</b> €193
	Nutzlänge	245 mm	275 mm	315 mm	230 mm

**Kontroll-Rohr mit Zuluftansaugung**

		<b>710755</b> €162	<b>711755</b> €198	<b>712755</b> €232	<b>713755</b> €264
	Nutzlänge	245 mm	275 mm	315 mm	315 mm

**Zuluftrohr**

		<b>710756</b> €118	<b>711756</b> €135	<b>712756</b> €168	<b>713756</b> €204
	Nutzlänge	255 mm	255 mm	255 mm	190 mm

**Zwischenkonsole**

		<b>710761</b> €186	<b>711761</b> €193	<b>712761</b> €223	<b>713761</b> €247
---	--	-----------------------	-----------------------	-----------------------	-----------------------

**Zwischenkonsole mit Zuluftöffnung**

		<b>710753</b> €196	<b>711753</b> €206	<b>712753</b> €235	<b>713753</b> €261
---	--	-----------------------	-----------------------	-----------------------	-----------------------

**30°-Bogen**

		<b>710714</b> €80	<b>711714</b> €96	<b>712714</b> €118	<b>713714</b> €142
---	--	----------------------	----------------------	-----------------------	-----------------------

**45°-Bogen**

		<b>710715</b> €80	<b>711715</b> €96	<b>712715</b> €118	<b>713715</b> €142
---	--	----------------------	----------------------	-----------------------	-----------------------

**87°-Bogen**

		<b>710716</b> €100	<b>711716</b> €100	<b>712716</b> €136	<b>713716</b> €165
---	--	-----------------------	-----------------------	-----------------------	-----------------------

DN 60/100 DN 80/125 DN 100/150 DN 110/160

**Aufsatzplatte 330x330 mm**

	250 mm	<b>710668</b> €168	<b>711668</b> €168	<b>712668</b> €198	<b>713668</b> €211
	Maße (mm)	330 x 330	330 x 330	330 x 330	330 x 330

**Klemmband, optional**

		<b>710740</b> €35	<b>711740</b> €35	<b>712740</b> €40	<b>713740</b> €48
---	--	----------------------	----------------------	----------------------	----------------------

 Abspannschellen siehe Seite 23

**Wandrosette**

		<b>710728</b> €53	<b>711728</b> €53	<b>712728</b> €53	<b>713728</b> €54
	Außen - Ø	240 mm	265 mm	290 mm	320 mm

**Stützbogen 87°**

		<b>710734</b> €259	<b>711734</b> €296	<b>712734</b> €308	<b>713734</b> €356
	Nutzlänge (NL)	78 mm	86 mm	100 mm	110 mm

mit Zuluftöffnung

**Verankerungsplatte**

		<b>710733</b> €94	<b>711733</b> €94	<b>712733</b> €97	<b>713733</b> €120
---	--	----------------------	----------------------	----------------------	-----------------------

**Wandabstandhalter**

	50 mm	<b>710742</b> €92	<b>711742</b> €92	<b>712742</b> €110	<b>713742</b> €112
	50-150 mm (kürzbar)	<b>710744</b> €111	<b>711744</b> €111	<b>712744</b> €127	<b>713744</b> €135
	50-360 mm (kürzbar)	<b>710745</b> €187	<b>711745</b> €187	<b>712745</b> €201	<b>713745</b> €207
	50-500 mm (kürzbar)	<b>710746</b> €216	<b>711746</b> €216	<b>712746</b> €233	<b>713746</b> €239

 Schrauben und Dübel bauseits nach Wandbeschaffenheit.

**Dachdurchführung 6° - 32° inkl. Wetterkragen**

		<b>700663</b> €323	<b>701663</b> €323	<b>702663</b> €373	<b>703663</b> €417
---	--	-----------------------	-----------------------	-----------------------	-----------------------

**Dachdurchführung 33° - 45° inkl. Wetterkragen**

		<b>700664</b> €323	<b>701664</b> €323	<b>702664</b> €373	<b>703664</b> €417
---	--	-----------------------	-----------------------	-----------------------	-----------------------

**Kompensatorelement 940 mm (nicht kürzbar)**

		<b>711721</b> €142	<b>712721</b> €200	<b>713721</b> €237
---	--	-----------------------	-----------------------	-----------------------

 In Leitungslängen mit Bögen  $\geq 3,0$  m erforderlich



 Einbau als oberstes Element

# AUßENWAND

ATEC | ABGASSYSTEME

DN 60/100 DN 80/125

**Dachhochführung**

	ziegelrot, 650 mm	
	<b>700757</b> €258	<b>701757</b> €272
	schwarz, 650 mm	
	<b>700758</b> €258	<b>701758</b> €272

 Schrägdachpfanne und Flachdachkragen  
siehe Seiten 22, 23 und 31.

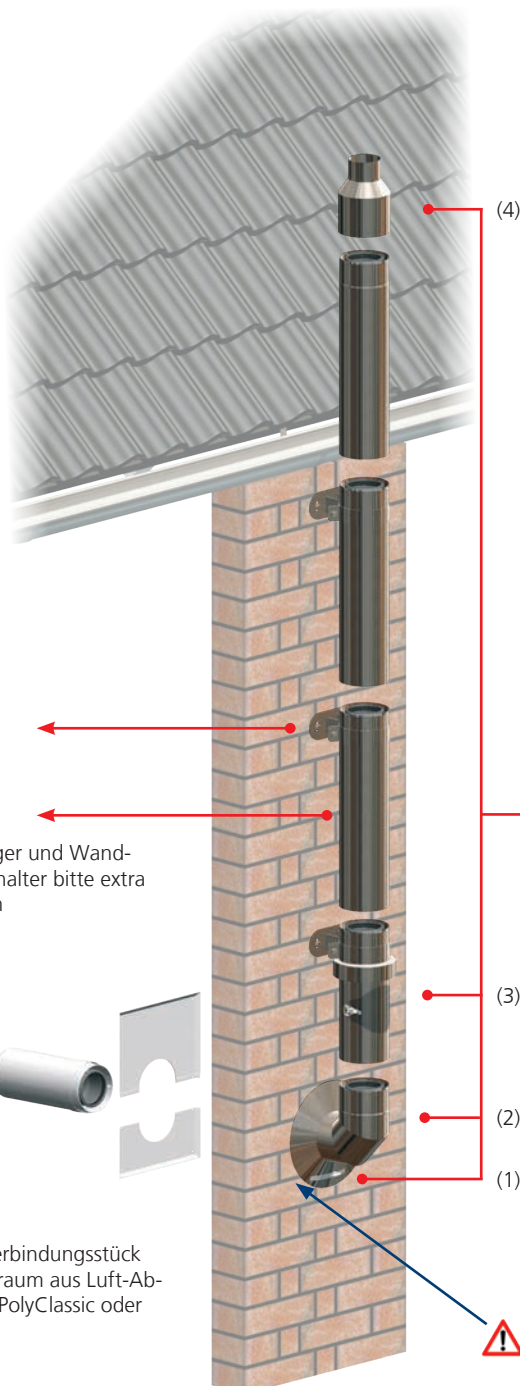
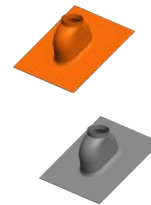

**IronPoly**  
Bauteile ab  
Seite 27

 Querträger und Wand-  
abstandhalter bitte extra  
bestellen

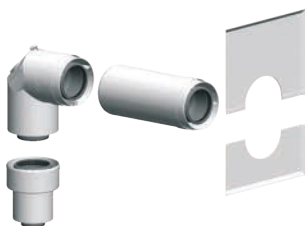

Beispiel: Verbindungsstück  
im Aufstellraum aus Luft-Ab-  
gassystem PolyClassic oder  
PolyTwin

**Basis-Set für die Installation an der Außenwand**

- (1) Wandrosette
- (2) 87°-Bogen
- (3) Kontroll-Rohr mit Zuluftansaugung
- (4) Mündungsabschluss

<b>IronPoly</b>	PP/Edelstahl blank	Nutzlänge
<b>DN 60/100</b>	<b>700770</b> €384	475 mm
<b>DN 80/125</b>	<b>701770</b> €419	530 mm
<b>DN 100/150</b>	<b>702770</b> €504	575 mm
<b>DN 110/160</b>	<b>703770</b> €570	585 mm

 Im Bereich der Wanddurch-  
führung ist WhitePoly oder  
IronPoly zu verwenden.

DN 60/100 DN 80/125 DN 100/150 DN 110/160

Mündungsabschluss	DN 60/100	DN 80/125	DN 100/150	DN 110/160
	700754 €72	701754 €72	702754 €88	703754 €91
Nutzlänge	145 mm	145 mm	145 mm	145 mm

Rohrelement, kürzbar	DN 60/100	DN 80/125	DN 100/150	DN 110/160
	Nutzlänge 190 mm			
	700717 €69	701717 €78	702717 €82	703717 €99
	Nutzlänge 440 mm			
	700718 €81	701718 €88	702718 €99	703718 €119
	Nutzlänge 940 mm			
	700719 €92	701719 €99	702719 €133	703719 €165

Kontroll-Rohr	DN 60/100	DN 80/125	DN 100/150	DN 110/160
	700703 €117	701703 €133	702703 €168	703703 €192
Nutzlänge	245 mm	275 mm	315 mm	230 mm

Kontroll-Rohr mit Zuluftansaugung	DN 60/100	DN 80/125	DN 100/150	DN 110/160
	700755 €162	701755 €197	702755 €231	703755 €263
Nutzlänge	245 mm	275 mm	315 mm	315 mm

Zuluftrohr	DN 60/100	DN 80/125	DN 100/150	DN 110/160
	700756 €117	701756 €134	702756 €167	703756 €204
Nutzlänge	255 mm	255 mm	255 mm	190 mm

Zwischenkonsole	DN 60/100	DN 80/125	DN 100/150	DN 110/160
	700761 €185	701761 €192	702761 €222	703761 €246

Zwischenkonsole mit Zuluftöffnung	DN 60/100	DN 80/125	DN 100/150	DN 110/160
	700753 €196	701753 €205	702753 €234	703753 €260

30°-Bogen	DN 60/100	DN 80/125	DN 100/150	DN 110/160
	700714 €80	701714 €96	702714 €117	703714 €141

45°-Bogen	DN 60/100	DN 80/125	DN 100/150	DN 110/160
	700715 €80	701715 €96	702715 €117	703715 €141

87°-Bogen	DN 60/100	DN 80/125	DN 100/150	DN 110/160
	700716 €99	701716 €99	702716 €136	703716 €164

 Abspannschellen siehe Seite 23

DN 60/100 DN 80/125 DN 100/150 DN 110/160

Klemmband, optional	DN 60/100	DN 80/125	DN 100/150	DN 110/160
	700740 €35	701740 €35	702740 €40	703740 €48

Aufsatzplatte	DN 60/100	DN 80/125	DN 100/150	DN 110/160
	700668 €167	701668 €167	702668 €197	703668 €210
Maße (mm)	330 x 330	330 x 330	330 x 330	330 x 330

Wandrosse	DN 60/100	DN 80/125	DN 100/150	DN 110/160
	700728 €53	701728 €53	702728 €53	703728 €54
Außen - Ø	240 mm	265 mm	290 mm	320 mm



Stützbogen 87°	DN 60/100	DN 80/125	DN 100/150	DN 110/160
	700734 €258	701734 €294	702734 €307	703734 €355
mit Zuluftöffnung				
Nutzlänge (NL)	78 mm	86 mm	100 mm	110 mm

Verankerungsplatte	DN 60/100	DN 80/125	DN 100/150	DN 110/160
	700733 €94	701733 €94	702733 €97	703733 €120



Wandabstandhalter	DN 60/100	DN 80/125	DN 100/150	DN 110/160
	50 mm			
	700742 €91	701742 €91	702742 €109	703742 €112
	50-150 mm (kürzbar)			
	700744 €111	701744 €111	702744 €126	703744 €134
	50-360 mm (kürzbar)			
	700745 €187	701745 €187	702745 €200	703745 €206
	50-500 mm (kürzbar)			
	700746 €215	701746 €215	702746 €232	703746 €238

 Diese Wandabstandhalter sind nicht mit Verlängerungen kombinierbar.  
Schrauben und Dübel bauseits nach Wandbeschaffenheit.

Wandabstandhalter 50 mm (mit Verlängerungen siehe Seite 30)	DN 60/100	DN 80/125	DN 100/150	DN 110/160
	700741 €69	701741 €69	702741 €69	703741 €74

Kragarm	DN 60/100	DN 80/125	DN 100/150	DN 110/160
	700799 €2118	701799 €2118	702799 €2118	703799 €2118
Weitere Hinweise und Bestellung siehe Planungs- und Montagehinweise für tragende Systembauteile Art.-Nr. 10001761				

Kompensatorelement 940 mm (nicht kürzbar)	DN 60/100	DN 80/125	DN 100/150	DN 110/160
	701721 €141	702721 €199	703721 €237	

 in Leitungslängen mit Bögen  $\geq 3,0$  m erforderlich  
 Einbau als oberstes Element

# AUßENWAND

**ATEC | ABGASSYSTEME**

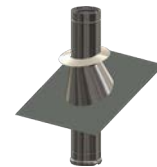
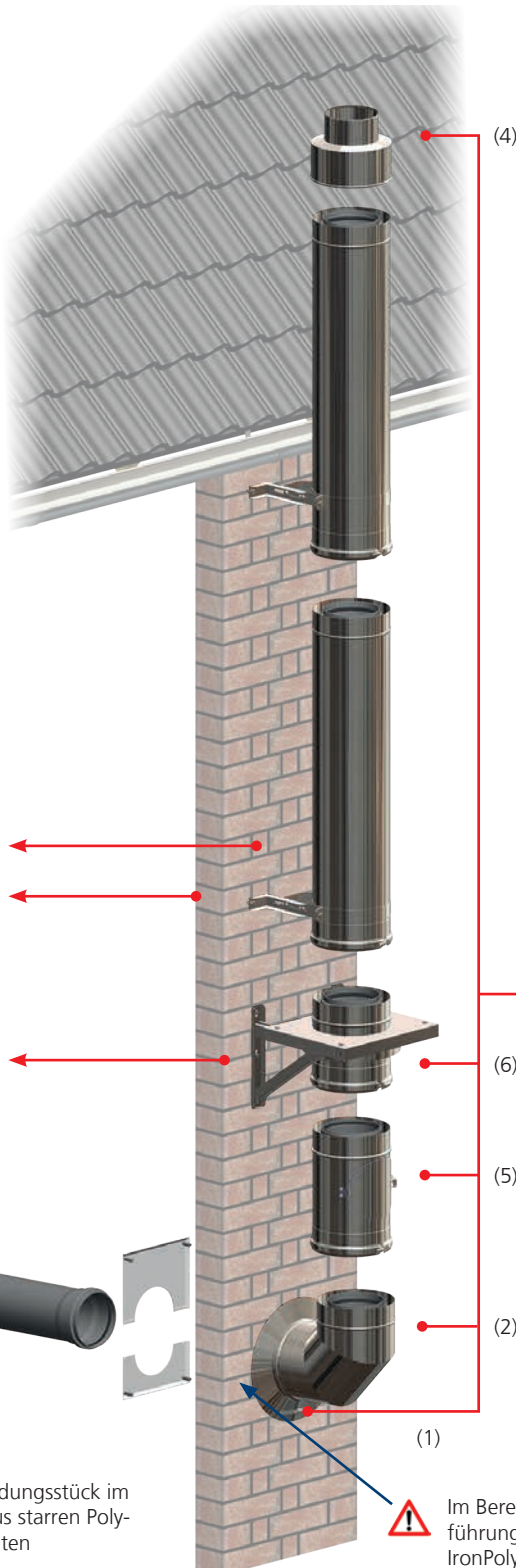

**!** Dachdurchführungen und Flachdachkragen siehe Seite 31

**IronPoly**  
Bauteile ab Seite 29

Querträger separat bestellen Seite 30



Beispiel: Verbindungsstück im Aufstellraum aus starren Poly-Top-Bauelementen

**Basis-Set für die Installation an der Außenwand**

- (1) Wandrosette
- (2) 87°-Bogen
- (5) Kontroll-Rohr
- (6) Zwischenkonsole mit Zu-  
luftöffnung
- (4) Mündungsabschluss

	PP/Edelstahl blank	Nutzlänge
<b>IronPoly</b> DN 125/190	704770 €1054	845 mm
DN 160/230	706770 €1269	865 mm
DN 200/265	708770 €1494	1.000 mm
DN 250/315	709770 €1810	1.100 mm

**!** Im Bereich der Wanddurchführung ist WhitePoly oder IronPoly zu verwenden.

DN 125/190 DN 160/230 DN 200/265 DN 250/315

**Erweiterung exzentrisch**

	<b>704797</b> €290	<b>706797</b> €348		
	D 100/150	D 100/150		
	<b>704798</b> €290	<b>706798</b> €348	<b>708798</b> €383	<b>709798</b> €452
	D 110/160	D 110/160	D 110/160	D 200/260

**Mündungsabschluss**

	<b>704754</b> €126	<b>706754</b> €136	<b>708754</b> €143	<b>709754</b> €153
Nutzlänge	200 mm	200 mm	200 mm	200 mm

**Rohrelement, kürzbar**

	Nutzlänge 190 mm			
	<b>704717</b> €126	<b>706717</b> €143	<b>708717</b> €162	<b>709717</b> €210
	Nutzlänge 440 mm			
	<b>704718</b> €143	<b>706718</b> €167	<b>708718</b> €205	<b>709718</b> €231
	Nutzlänge 940 mm			
	<b>704719</b> €196	<b>706719</b> €231	<b>708719</b> €289	<b>709719</b> €401

**Kontroll-Rohr**

	<b>704703</b> €332	<b>706703</b> €425	<b>708703</b> €503	<b>709703</b> €596
Nutzlänge	270 mm	280 mm	400 mm	480 mm

**Zuluftrohr**

	<b>704784</b> €231	<b>706784</b> €299	<b>708784</b> €366	<b>709784</b> €443
Nutzlänge	255 mm	255 mm	255 mm	255 mm

**Zwischenkonsole**

	<b>704761</b> €258	<b>706761</b> €330	<b>708761</b> €419	<b>709761</b> €524
---	-----------------------	-----------------------	-----------------------	-----------------------

**Zwischenkonsole mit Zuluftöffnung**

	<b>704753</b> €272	<b>706753</b> €349	<b>708753</b> €443	<b>709753</b> €554
Nutzlänge	255 mm	255 mm	255 mm	255 mm

**30°-Bogen**

	<b>704714</b> €167	<b>706714</b> €200	<b>708714</b> €264	<b>709714</b> €349
---	-----------------------	-----------------------	-----------------------	-----------------------

**45°-Bogen**

	<b>704715</b> €167	<b>706715</b> €207	<b>708715</b> €265	<b>709715</b> €349
---	-----------------------	-----------------------	-----------------------	-----------------------

**87°-Bogen**

	<b>704716</b> €268	<b>706716</b> €299	<b>708716</b> €339	<b>709716</b> €425
---	-----------------------	-----------------------	-----------------------	-----------------------

 87°-Kontroll-Bogen siehe Seite 37

DN 125/190 DN 160/230 DN 200/265 DN 250/315

**Aufsatzplatte**

	<b>704752</b> €126	<b>706752</b> €136	<b>708752</b> €143	<b>709752</b> €153
Maße (mm)	400 x 400	500 x 500	550 x 550	600 x 600

**Abspannschelle**

	<b>644459</b> €108	<b>646459</b> €117	<b>648459</b> €128	<b>649459</b> €146
---	-----------------------	-----------------------	-----------------------	-----------------------

 Spannseile sind bauseits zu bestellen.

**Zuluftelement für raumluftunabhängige Betriebsweise**

	<b>704755</b> €162	<b>706755</b> €205	<b>708755</b> €255	<b>709755</b> €332
D	D 125	D 160	D 200	D 250
Nutzlänge	440 mm	440 mm	440 mm	440 mm

**Wandrosette**

	<b>704728</b> €57	<b>706728</b> €63	<b>708728</b> €69	<b>709728</b> €75
Außen-Ø	320 mm	360 mm	395 mm	445 mm

**Stützbogen 87°**

	<b>704734</b> €472	<b>706734</b> €518	<b>708734</b> €592	<b>709734</b> €786
Nutzlänge (NL)	150 mm	170 mm	220 mm	245 mm

mit Zuluftöffnung

 In Kombination mit der Verankerungsplatte zum Aufbau auf einem Fundamentsockel.

**Verankerungsplatte**

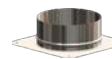
	<b>704733</b> €125	<b>706733</b> €128	<b>708733</b> €132	<b>709733</b> €146
Maße (mm)	260 x 260	320 x 320	350 x 350	400 x 400

**Wandabstandhalter (mit Verlängerungen siehe Seite 30)**

	<b>704742</b> €75	<b>706742</b> €81	<b>708742</b> €83	<b>709742</b> €87
---	----------------------	----------------------	----------------------	----------------------

**Kragarm**

	<b>704799</b> €2118	<b>706799</b> €2118
---	------------------------	------------------------

Weitere Hinweise und Bestellung siehe Planungs- und Montagehinweise für tragende Systembauteile Art.-Nr. 10001761



**Kompensatorelement 940 mm (nicht kürzbar)**

	<b>704721</b> €276	<b>706721</b> €332
---	-----------------------	-----------------------

 in Leitungslängen mit Bögen  $\geq 3,0$  m erforderlich

 Einbau als oberstes Element

DN 60/100 DN 80/125 DN 100/150 DN 110/160 DN 125/190 DN 160/230 DN 200/265 DN 250/315

**Konsolbleche, verstellbar 50 - 150 mm (Paar: links und rechts)**



<b>704771</b> €170	<b>706771</b> €205	<b>708771</b> €289	<b>709771</b> €383
-----------------------	-----------------------	-----------------------	-----------------------

**Querträger, kürzbar (Set: 2 Stück)**

500 mm	Edelstahl weiß	<b>714746</b> €245							
	Edelstahl blank	<b>704746</b> €245							
li. Wandabstand WA									
Verankerungsplatte	min.	103 mm <sup>1)</sup>	90 mm <sup>1)</sup>	78 mm <sup>1)</sup>	73 mm <sup>1)</sup>	50 mm	50 mm	50 mm	50 mm
	max.	332 mm	320 mm	307 mm	303 mm	275 mm	275 mm	195 mm	142 mm
Zwischenkonsole	min.	120 mm <sup>1)</sup>	95 mm <sup>1)</sup>	70 mm <sup>1)</sup>	60 mm <sup>1)</sup>	50 mm	50 mm	50 mm	50 mm
	max.	350 mm	325 mm	300 mm	290 mm	262 mm	217 mm	195 mm	145 mm

750 mm	Edelstahl weiß	<b>714747</b> €300							
	Edelstahl blank	<b>704747</b> €299							
li. Wandabstand WA									
Verankerungsplatte	min.	303 mm	290 mm	278 mm	273 mm	245 mm	195 mm	163 mm	103 mm
	max.	582 mm	570 mm	557 mm	553 mm	525 mm	475 mm	442 mm	392 mm
Zwischenkonsole	min.	320 mm	295 mm	270 mm	260 mm	232 mm	188 mm	165 mm	115 mm
	max.	600 mm	575 mm	550 mm	540 mm	512 mm	467 mm	455 mm	395 mm

1030 mm	Edelstahl weiß	<b>714749</b> €490							
	Edelstahl blank	<b>704749</b> €489							
li. Wandabstand WA									
Verankerungsplatte	min.	583 mm	570 mm	558 mm	533 mm	525 mm	475 mm	443 mm	393 mm
	max.	862 mm	850 mm	837 mm	833 mm	805 mm	755 mm	722 mm	672 mm
Zwischenkonsole	min.	600 mm	575 mm	550 mm	540 mm	513 mm	468 mm	445 mm	375 mm
	max.	880 mm	855 mm	830 mm	820 mm	792 mm	747 mm	725 mm	675 mm

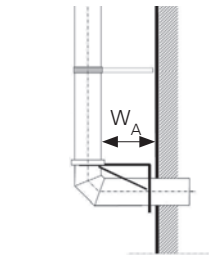

<sup>1)</sup> Bei Reduzierung der min. Wandabstände auf 50 mm müssen die Querstreben entfallen und ggf. die Belastung der Abstützung überprüft werden!



**Hinweis:** Für Wandabstände größer 360 mm ist, unter Berücksichtigung der Wandbaustoffe, ein bauseitiger statischer Nachweis über die zulässigen Lastableitungen in die Wand zu führen. Hierbei sind die Auszugswerte der Schwerlastanker zu beachten.

**Verlängerungen für 700741 bis 709742 (siehe Seite 27 und 29), (Set: 2 Stück)**

**Verlängerung für Wandabstandhalter 60 - 140 mm**



**704743**  
€75

**Verlängerung für Wandabstandhalter 80 - 240 mm**



**704744**  
€84

**Verlängerung für Wandabstandhalter 50 - 350 mm**



**704745**  
€92

**Verlängerung für Wandabstandhalter 50 - 450 mm**



**704750**  
€143

**Verlängerung für Wandabstandhalter 50 - 700 mm**



**704751**  
€199

**Verlängerung für Wandabstandhalter 50 - 1100 mm**



**704756**  
€220

DN 60/100 DN 80/125 DN 100/150 DN 110/160 DN 125/190 DN 160/230 DN 200/265 DN 250/315

**Flachdachkragen 0° - 5° inkl. Wetterkragen**



Außenmaß  
in mm

Aufsatzplatte von Seite 27 verwenden

<b>704666</b> €243	<b>706666</b> €280	<b>708666</b> €369	<b>709666</b> €416
606x606	646x646	681x681	731x731

**Flexible Flachdachdurchführung**

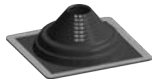

<b>701610</b> €255	<b>702610</b> €255
-----------------------	-----------------------

**Dachdurchführung 6° - 32° inkl. Wetterkragen**



Außenmaß  
in mm

<b>700663</b> €323	<b>701663</b> €323	<b>702663</b> €373	<b>703663</b> €417	<b>704768</b> €425	<b>706768</b> €461	<b>708663</b> €561	<b>709663</b> €609
651x618	676x645	701x671	711x681	741x714	781x756	816x793	866x846

**Dachdurchführung 33° - 45° inkl. Wetterkragen**

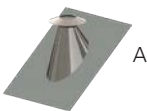

Außenmaß  
in mm

<b>700664</b> €323	<b>701664</b> €323	<b>702664</b> €373	<b>703664</b> €417	<b>704769</b> €425	<b>706769</b> €461	<b>708664</b> €561	<b>709664</b> €609
651x787	676x819	701x851	711x863	741x903	781x954	816x999	866x1063

**Vario-Dachflansch (Edelstahl) mit Dampfbremse**

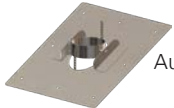

0° - 30°  
Außenmaß  
in mm

<b>440464</b> €298	<b>440465</b> €298	<b>440235</b> €298	<b>440233</b> €326	<b>440239</b> €343	<b>440246</b> €344	<b>440152</b> €537	<b>440466</b> €595
480x480	480x480	480x480	480x480	480x480	480x480	480x480	480x480

30° - 60°  
Außenmaß  
in mm

<b>440500</b> €298	<b>440501</b> €298	<b>440502</b> €298	<b>440245</b> €314	<b>440503</b> €343	<b>440504</b> €364	<b>440505</b> €537	<b>440506</b> €595
480x480	480x480	480x480	480x480	480x630	480x710	540x780	540x880

**Anwendungsbeispiele Vario-Dachflansch**

Entsprechend der EnEV (Energieeinsparverordnung) sind Dächer nicht nur zu dämmen, sondern auch gegen unkontrollierte Luftströmungen abzudichten und Lüftungswärmeverluste zu vermeiden. Dach-Durchdringungen von Abgasanlagen gegenüber Warmräumen kommt hierbei eine besondere Bedeutung zu. Raumseitig ist mit Luft- und Dampfbremsen eine Luftdichtheitsschicht zu gewährleisten.

Der Vario-Dachflansch, in Verbindung mit Klebemanschetten, vereinfacht die Herstellung einer fachgerechten und winddichten Dachdurchdringung.

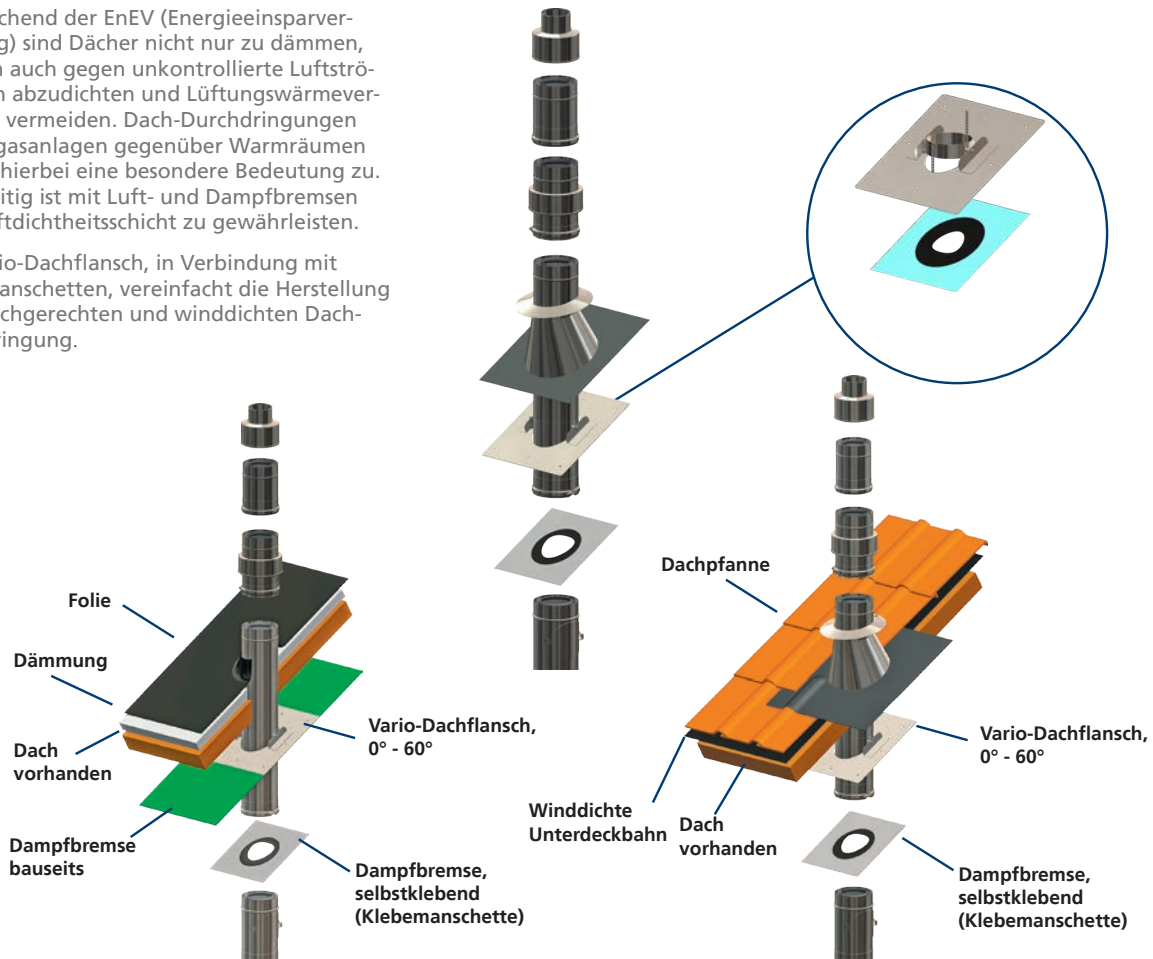

AUßENWAND



ATEC – eine handwerker- und betreiberfreundliche Langzeitlösung für typische Außenwand-Installationen, für Neu- und Altbauten und Speziallösungen.



### Edelstahl V4A

Beständige Außenschale gegen belastete Umgebungsluft wie z.B. salzhaltige See oder Industrieemissionen

+50 % Aufschlag,  
mindestens € 200

Artikelnummern: 74xxxx



### Außenrohr verkupfert Edelstahl gebürstet

+50 % Aufschlag,  
mindestens € 200

Artikelnummern  
verkupfert: 72xxxx  
Edelstahl gebürstet: 73xxxx

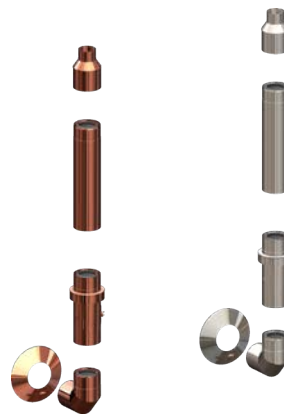

Kupfer-Design

gebürstet

### RAL-Farbe nach Wahl

+50 % Aufschlag,  
mindestens € 200

Artikelnummern: 75xxxx

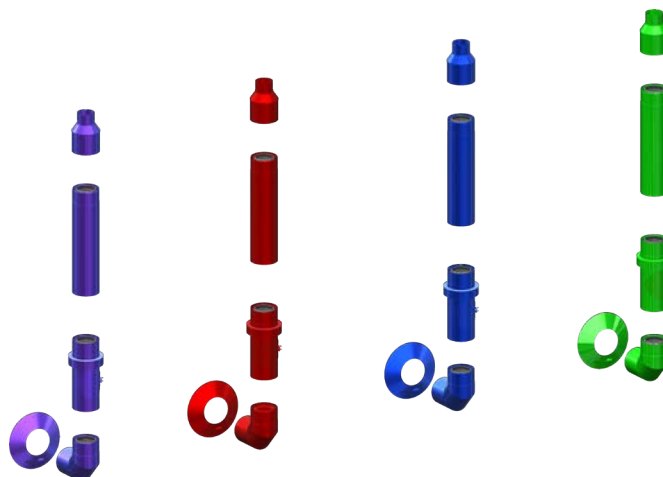

 Lieferzeit bei allen Sonderoberflächen bei allen DN Größen ca. 4 - 6 Wochen. Rückgabe bei Sonderoberflächen ausgeschlossen.

Beispiel: Das Basis-Set DN 60/100 (Art.Nr. 700770) hat in verkupfelter Ausführung die Art-Nr. 720770

# KASKADEN

## ATEC | ABGASSYSTEME

**Kaskade raumluftabhängig** (mehrfach belegtes, gemeinsames Verbindungsstück für Unter- oder Überdruckbetrieb)

**Basis-Set Kaskade:**

- (1) Endstück mit Kondensatablauf
- (2) 2 m Kondensatschlauch
- (3) Siphon
- (4) Rohr 255 mm
- (5) Kontroll-Rohr
- (6) Wandblende mit Hinterlüftung

**PolyTop**

DN 80	<b>601375</b> € 196
DN 100	<b>602375</b> € 218
DN 110	<b>603375</b> € 240
DN 125	<b>604375</b> € 303
DN 160	<b>606375</b> € 372
DN 200	<b>608375</b> € 468
DN 250	<b>609375</b> € 725

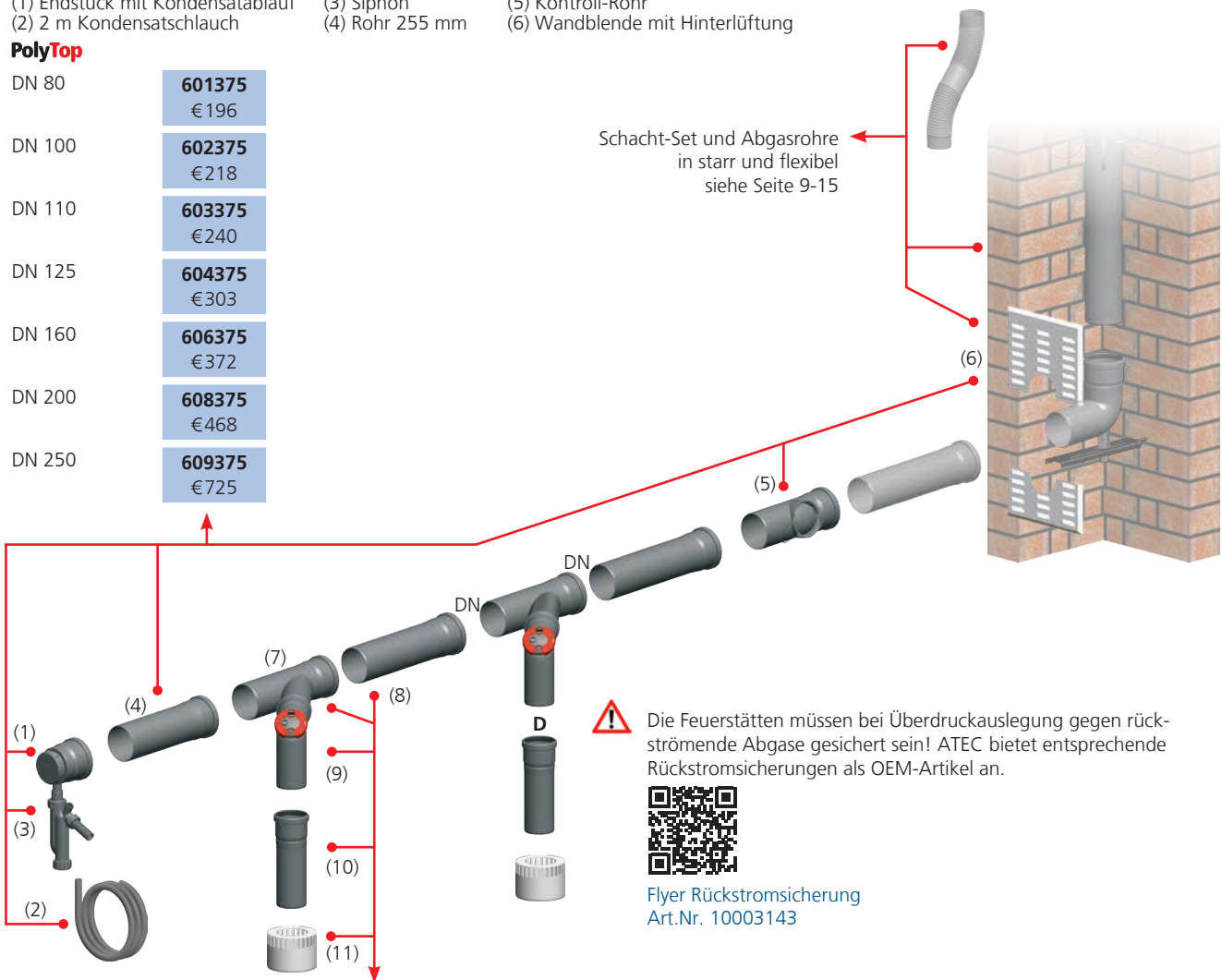

**Erweiterungs-Set bestehend aus:**

- (7) Abzweig 42°
- (8) Rohr 955 mm
- (9) 87°-Kontroll-Bogen
- (10) Rohr 255 mm
- (11) Luftgitter bis DN 110

PolyTop	D 80	D 100	D 110	D 125	D 160	D 200
DN 80	<b>601381</b> € 165	DN 125 <b>604382</b> € 251	DN 125 <b>604383</b> € 346	DN 160 <b>606384</b> € 457	DN 200 <b>608383</b> € 427	DN 250 <b>609384</b> € 783
DN 100	<b>602381</b> € 187	DN 160 <b>606382</b> € 330	DN 160 <b>606383</b> € 432	DN 200 <b>608384</b> € 469	DN 250 <b>609383</b> € 719	
DN 110	<b>603381</b> € 232	DN 200 <b>608382</b> € 396	DN 200 <b>608385</b> € 500	DN 250 <b>609386</b> € 574		
DN 125	<b>604381</b> € 232	DN 250 <b>609382</b> € 459	DN 250 <b>609385</b> € 620			

**Kaskade raumluftunabhängig** (mehrfach belegtes, gemeinsames Verbindungsstück)

DN 80/125    DN 110/160

**87°-Kontroll-Bogen, konzentrisch**



<b>1501</b> €125	<b>3501</b> €191
---------------------	---------------------

**Kontroll-Rohr, konzentrisch**



<b>1503</b> €112	<b>3503</b> €177
---------------------	---------------------

**87°-Bogen, konzentrisch**



<b>1516</b> €81	<b>3516</b> €105
--------------------	---------------------

**Rohr, konzentrisch, kürzbar**



Nutzlänge	DN 80/125	DN 110/160
255 mm	<b>1517</b> €49	<b>3517</b> €72
500 mm	<b>1518</b> €59	<b>3518</b> €87
955 mm	<b>1519</b> €86	<b>3519</b> €117

DN 80/125    DN 110/160

**T-Stück für Kaskade**



<b>1504</b> €178	<b>3504</b> €180
D80/125	D110/160

**T-Stück für Kaskade**



<b>3505</b> €180
D80/125

**Kaskade mit Luft-Abgas-System**

Abbildung zeigt das Luft-Abgassystem PolyTwin, auch als System PolyClassic in DN 80/125 oder 100/150 lieferbar

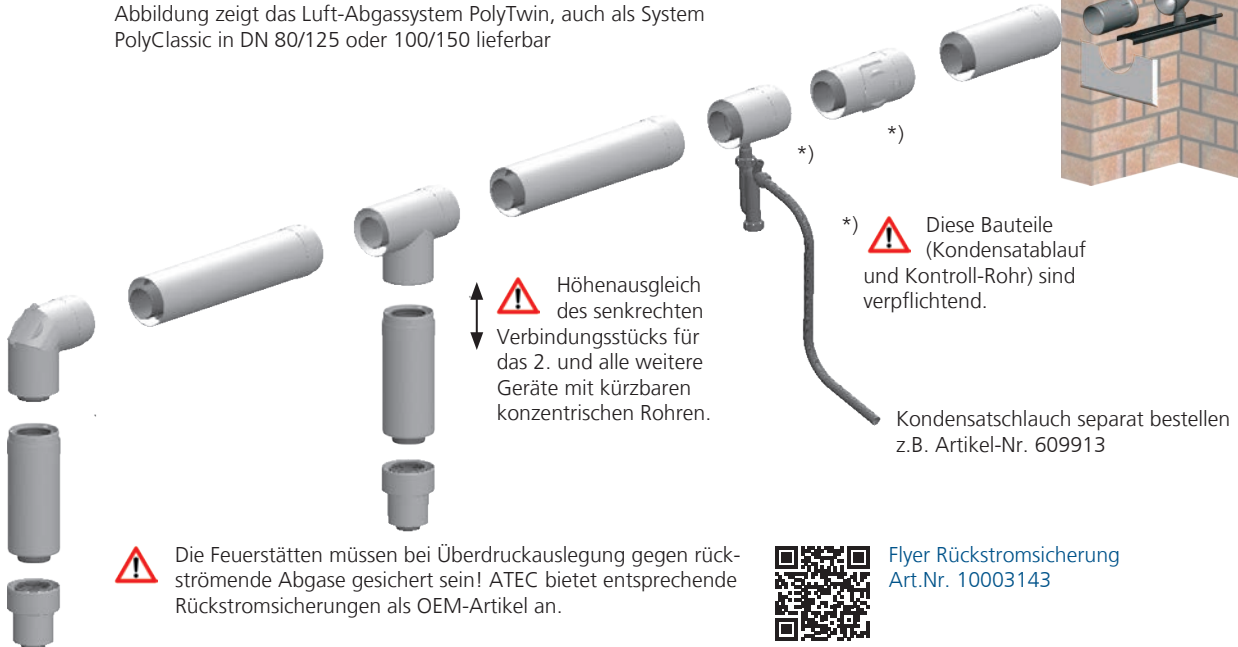

Schacht-Set und Abgasrohre in starr und flexibel siehe Seite 9-15

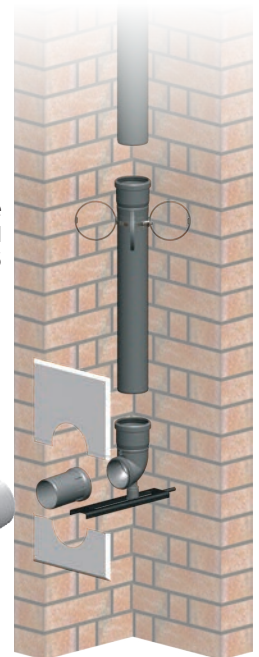

KASKADEN

DN 80/125    DN 110/160

**Erweiterung**



D60/100	<b>1866</b> €61	<b>3264</b> €127
D80/125		<b>3266</b> €84

DN 80/125    DN 110/160

**Kondensatablauf, konzentrisch mit Siphon**



<b>1548</b> €81	<b>3548</b> €95
--------------------	--------------------

**Wandblende geschlossen**



<b>1428</b> €44	<b>3428</b> €48
--------------------	--------------------

# KASKADEN

ATEC | ABGASSYSTEME

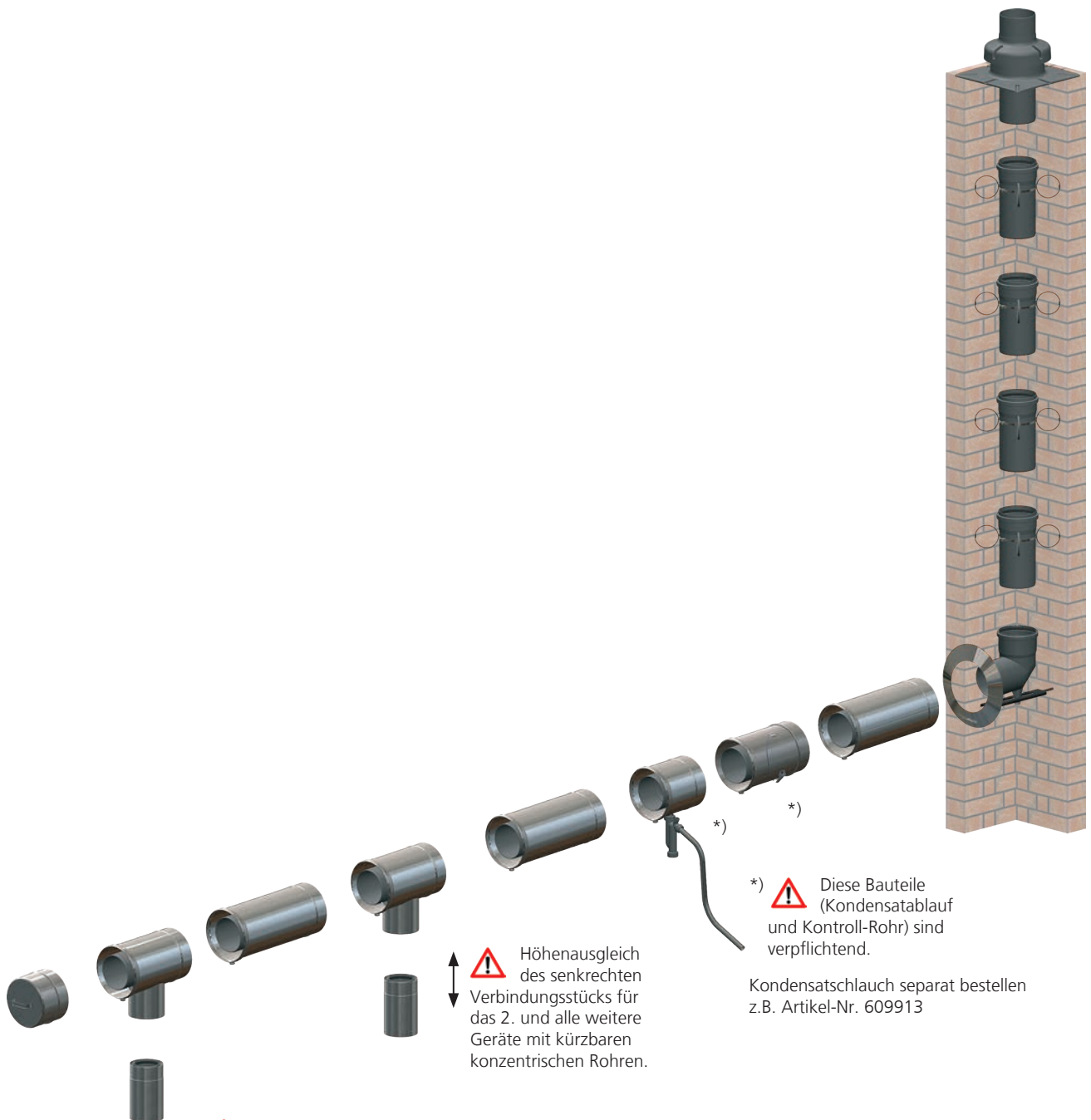

⚠ Höhenausgleich des senkrechten Verbindungsstücks für das 2. und alle weitere Geräte mit kürzbaren konzentrischen Rohren.

\*) ⚠ Diese Bauteile (Kondensatablauf und Kontroll-Rohr) sind verpflichtend.

Kondensatschlauch separat bestellen z.B. Artikel-Nr. 609913

⚠ Die Feuerstätten müssen bei Überdruckauslegung gegen rückströmende Abgase gesichert sein! ATEC bietet entsprechende Rückstromsicherungen als OEM-Artikel an.



Flyer Rückstromsicherung  
Art.Nr. 10003143

**Kaskade raumluftunabhängig** (mehrfach belegtes, gemeinsames Verbindungsstück)

DN 125/190 DN 160/230 DN 200/265

**87°-Kontroll-Bogen, konzentrisch**



<b>704701</b> €348	<b>706701</b> €378	<b>708701</b> €437
-----------------------	-----------------------	-----------------------

**Kontroll-Rohr, konzentrisch**



<b>704703</b> €332	<b>706703</b> €425	<b>708703</b> €503
-----------------------	-----------------------	-----------------------

**87°-Bogen, konzentrisch**



<b>704716</b> €268	<b>706716</b> €299	<b>708716</b> €339
-----------------------	-----------------------	-----------------------

**Rohr, konzentrisch, kürzbar**

Nutzlänge 190 mm



<b>704717</b> €126	<b>706717</b> €143	<b>708717</b> €162
<b>704718</b> €143	<b>706718</b> €167	<b>708718</b> €205
<b>704719</b> €196	<b>706719</b> €231	<b>708719</b> €289

DN 125/190 DN 160/230 DN 200/265

**Kondensatablauf, konzentrisch mit Siphon**



<b>704748</b> €263	<b>706748</b> €281	<b>708748</b> €346
-----------------------	-----------------------	-----------------------

**T-Stück für Kaskade**



**NEU** **NEU**

<b>704706</b> €306	<b>706706</b> €331
-----------------------	-----------------------

D80/125 D80/125

<b>704705</b> €350	<b>706705</b> €383	<b>708705</b> €466
-----------------------	-----------------------	-----------------------

D110/160 D110/160 D110/160

**Enddeckel für Kaskade**



<b>704709</b> €226	<b>706709</b> €237	<b>708709</b> €275
-----------------------	-----------------------	-----------------------

Erweiterungen siehe Seite 21

# MEHRFACHBELEGUNG

## ATEC | ABGASSYSTEME

### Mehrfachbelegung im vorhandenen Schacht DN 100, 125 und 160

Bis zu 10 Gasgeräte bis maximal 30 kW je Gerät an eine gemeinsame Abgasleitung anschließbar  
(Allgemeine Bauartgenehmigung Z-7.5-3356)

Allgemeine Bauartgenehmigung Nr. Z-7.5-3356  
für den Anschluss einzelner oder mehrerer fabri-  
katsunabhängiger Gasgeräte mit C4 (Unterdruck),  
C6 und C(10) (Überdruck) Kennzeichnung.

Wichtig für Wohnungsgesellschaften: Die Gasge-  
räte müssen kein einheitliches Fabrikat sein, was  
den Tausch der Geräte vereinfacht.



Montage von vorne:  
Frontage-Set

**!** Die Verbindungsleitung muss aus PolyClassic- Bauteilen  
erstellt werden.  
Die Verbindungsleitung aus PolyClassic-Luft-Abgassys-  
tembauteile sind bauaufsichtlich geprüfter Bestandteil der  
Allgemeinen Bauartgenehmigung Z-7.5-3356.

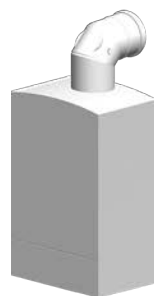

**Rohr starr oder  
flexibel einsetzbar.**  
Separat bestellen siehe  
Seiten 10 und 11.

**Nur Rohr flexibel  
einsetzbar.**  
Separat bestellen  
siehe Seite 11.

**Rohr starr oder  
flexibel einsetzbar.**  
Separat bestellen siehe  
Seiten 10 und 11.

**!** Die Feuerstätten müssen bei Überdruckauslegung gegen rück-  
strömende Abgase gesichert sein! ATEC bietet entsprechende  
Rückstromsicherungen als OEM-Artikel an.



Flyer Rückstromsicherung  
Art.Nr. 10003143

DN 60/100    DN 80/125

**87°-Kontroll-Bogen, konzentrisch**



<b>0401</b> € 130	<b>1401</b> € 131
----------------------	----------------------

**Kontroll-Rohr, konzentrisch**



<b>0403</b> € 104	<b>1403</b> € 115
----------------------	----------------------

**30°-Bogen, konzentrisch**



<b>0414</b> € 58	<b>1414</b> € 58
---------------------	---------------------

**45°-Bogen, konzentrisch**



<b>0415</b> € 59	<b>1415</b> € 59
---------------------	---------------------

**87°-Bogen, konzentrisch**



<b>0416</b> € 82	<b>1416</b> € 83
---------------------	---------------------

**Rohr, konzentrisch, kürzbar**



Nutzlänge 255 mm

<b>0417</b> € 45	<b>1417</b> € 52
---------------------	---------------------

500 mm

<b>0418</b> € 55	<b>1418</b> € 61
---------------------	---------------------

955 mm

<b>0419</b> € 72	<b>1419</b> € 90
---------------------	---------------------

DN 100    DN 125

**Blinddeckel für Mehrfachbelegung**



<b>0409</b> € 38	<b>1409</b> € 58
---------------------	---------------------

DN 60    DN 80

**Endeckel mit Muffe**



<b>490065</b> € 33	<b>490058</b> € 36
-----------------------	-----------------------

DN 100    DN 125    DN 160

**Basis-Set Mehrfachbelegung**

- (1) Siphon und Kondensatschlauch 1,5 m
- (2) Kontroll-Rohr mit Kondensatablauf und Auflager
- (3) Fixschellen
- (4) Flexrohrhülse
- (5) Mündungs-Set



<b>632394</b> € 235	<b>634394</b> € 291	<b>636394</b> € 358
------------------------	------------------------	------------------------

**Anschluss-Set Mehrfachbelegung**

- (1) Schachtblende
- (2) Wandfutter mit Inbusschraube
- (3) Rohr 255 mm
- (4) Schraubdeckel für T-Stück
- (5) T-Stück mit SV-Anschluss
- (6) Flexrohrhülse 2x
- (7) Fixschellen 2x
- (8) Brandschutzkleber
- (9) Befestigungsset Wandblende

DN 60/100

<b>632380</b> € 209	<b>634380</b> € 257	<b>636380</b> € 358
------------------------	------------------------	------------------------

DN 80/125

<b>632381</b> € 209	<b>634381</b> € 257	<b>636381</b> € 487
------------------------	------------------------	------------------------

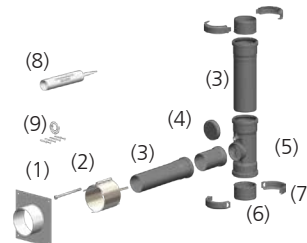

Das Anschluss-Set enthält jetzt standardmäßig das Frontage-Set zur einfachen Montage von vorne.

**Kondensatabführung über Schacht**

- (1) Kondensatabführung
- (2) Fixschellen
- (3) Flexrohrhülsen
- (4) 0,5 m Schlauch 3/4"

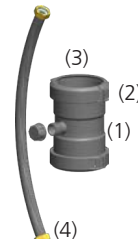

<b>632393</b> € 178	<b>634393</b> € 209	<b>636393</b> € 225
------------------------	------------------------	------------------------

Kondensateinleitung in die Abgasleitung

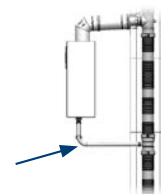

alle DN

**Kondensatschlauchverbinder**



<b>601336</b> € 31
-----------------------

# MEHRFACHBELEGUNG

## ATEC | ABGASSYSTEME

### Mehrfachbelegung im vorhandenen Schacht DN 80 und 110

Bis zu 10 Gasgeräte bis maximal 30 kW je Gerät an eine gemeinsame Abgasleitung anschließbar  
(Allgemeine Bauartgenehmigung Z-7.5-3356)

#### Das neue Flexrohr-Bajonett-System

- Lieferbar in 2 m Stangen Flexrohr
- vorinstalliertes Verbindungssystem
- leicht auf das Dach transportierbar
- einfach im Schacht installierbar durch konische Verbindungsstücke - schlanker als bisheriges System
- kürzbar/teilbar

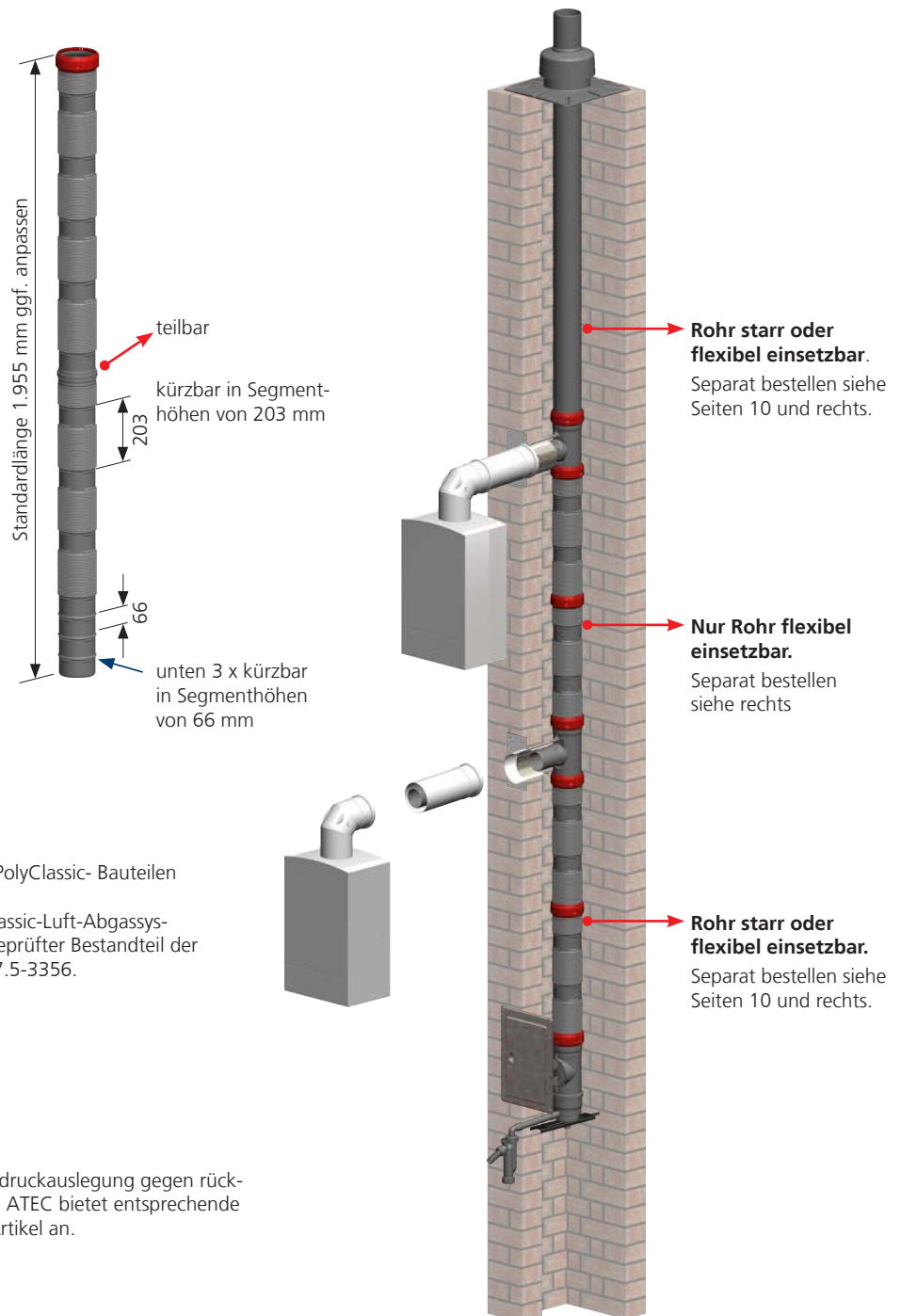

**!** Die Verbindungsleitung muss aus PolyClassic- Bauteilen erstellt werden.  
Die Verbindungsleitung aus PolyClassic-Luft-Abgassystembauteile sind bauaufsichtlich geprüfter Bestandteil der Allgemeine Bauartgenehmigung Z-7.5-3356.

**!** Die Feuerstätten müssen bei Überdruckauslegung gegen rückströmende Abgase gesichert sein! ATEC bietet entsprechende Rückstromsicherungen als OEM-Artikel an.



Flyer Rückstromsicherung  
Art.Nr. 10003143



DN 60/100    DN 80/125

**87°-Kontroll-Bogen, konzentrisch**



<b>0401</b> € 130	<b>1401</b> € 131
----------------------	----------------------

**Kontroll-Rohr, konzentrisch**



<b>0403</b> € 104	<b>1403</b> € 115
----------------------	----------------------

**30°-Bogen, konzentrisch**



<b>0414</b> € 58	<b>1414</b> € 58
---------------------	---------------------

**45°-Bogen, konzentrisch**



<b>0415</b> € 59	<b>1415</b> € 59
---------------------	---------------------

**87°-Bogen, konzentrisch**



<b>0416</b> € 82	<b>1416</b> € 83
---------------------	---------------------

**Rohr, konzentrisch, kürzbar**



Nutzlänge 255 mm

<b>0417</b> € 45	<b>1417</b> € 52
---------------------	---------------------

500 mm

<b>0418</b> € 55	<b>1418</b> € 61
---------------------	---------------------

955 mm

<b>0419</b> € 72	<b>1419</b> € 90
---------------------	---------------------

DN 100    DN 125

**MFB Blinddeckel**



<b>0409</b> € 38	<b>1409</b> € 58
---------------------	---------------------

DN 60    DN 80

**Enddeckel mit Muffe**



<b>490065</b> € 33	<b>490058</b> € 36
-----------------------	-----------------------

DN 80    DN 110

**MFB Rohr flexibel 1955 mm**



<b>651322</b> € 101	<b>653322</b> € 130
------------------------	------------------------

Bei Verwendung Rohr flexibel bis zur Mündung geeignete Flexrohraufhängung wählen, siehe Seite 20

**MFB Kontroll-Rohr flexibel**



<b>651304</b> € 121	<b>653304</b> € 146
------------------------	------------------------

DN 80    DN 110

**MFB Basis-Set**

- (1) Siphon und Kondensatschlauch 1,5 m
- (2) Kontroll-Rohr mit Kondensatablauf und Auflager
- (3) Bajonettverschluss
- (4) Flexrohrhülse
- (5) Mündungs-Set



<b>651389</b> € 248	<b>653389</b> € 353
------------------------	------------------------



**MFB Anschluss-Set**

- (1) Schachtblende
- (2) Wandfutter
- (3) Rohr 255 mm
- (4) Schraubdeckel für T-Stück
- (5) T-Stück mit SV-Anschluss
- (6) Flexrohrhülse
- (7) Brandschutzkleber

DN 60/100	<b>651392</b> € 284	<b>653392</b> € 333
-----------	------------------------	------------------------

DN 80/125	<b>651393</b> € 296	<b>653393</b> € 345
-----------	------------------------	------------------------

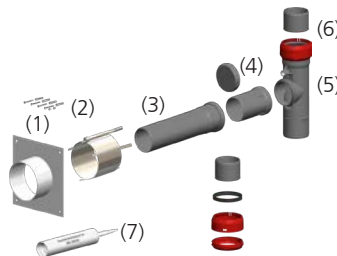

**MFB Kondensatabführung über Schacht**

- (1) Kondensatabführung
- (2) Bajonettverbindung
- (3) 0,5 m Schlauch 3/4"

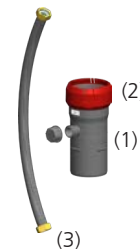

<b>651394</b> € 205	<b>653394</b> € 229
------------------------	------------------------

Kondensateinleitung in die Abgasleitung

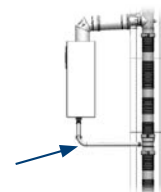

alle DN

**Kondensatschlauchverbinder**



<b>601336</b> € 31
-----------------------

**Mehrfachbelegung DN 100, 125 und DN 160  
Fixschellen-System**

**Abdeckplatte für Kopfverkleidung  
(inkl. Mündungshaube)**

DN 100	DN 125	DN 160
300 x 300	300 x 300	350 x 350
<b>300100</b> €290	<b>300125</b> €302	<b>350160</b> €329

 Die Feuerstätten müssen bei Überdruckauslegung gegen rückströmende Abgase gesichert sein! ATEC bietet entsprechende Rückstromsicherungen als OEM-Artikel an.



Flyer Rückstromsicherung  
Art.Nr. 10003143

**Feuerstättenanschluss DN 60/100**

DN 100	DN 125	DN 160
<b>632370</b> €264	<b>634370</b> €300	<b>636370</b> €321

**Feuerstättenanschluss DN 80/125**

DN 100	DN 125	DN 160
<b>632371</b> €264	<b>634371</b> €300	<b>636371</b> €321

- (1) Eintauchstück
- (2) Schachtblende + Befestigungsset
- (3) Wandfutter + Inbusschraube
- (4) MFB T-Stück 87°



DN 100, 125 und 160 Flexrohr  
als Set oder per Meter separat  
bestellen siehe Seite 11.

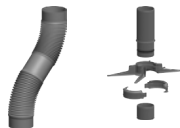

**Kontroll-Rohr mit Kondensatablauf**

DN 100	DN 125	DN 160
<b>632349</b> €168	<b>634349</b> €216	<b>636349</b> €244

- (1) Siphon und Kondensatschlauch 1,5 m
- (2) Kontroll-Rohr mit Kondensatablauf
- (3) Fixschellen
- (4) Flexrohrhülse

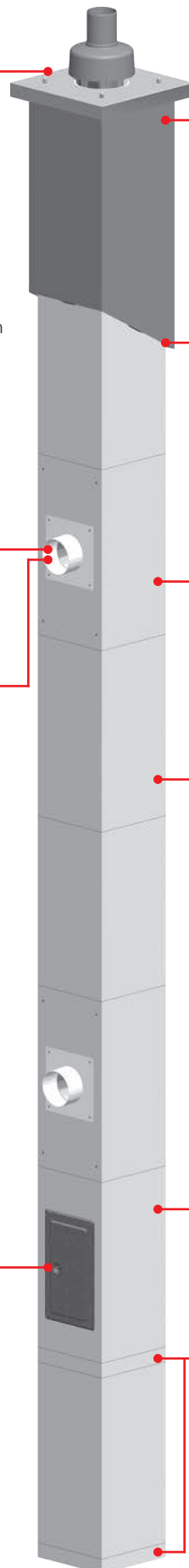
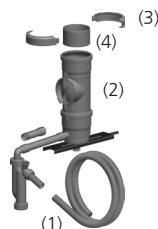

**DN 100**  
**DN 125**      **DN 160**

**Kopfverkleidung für Schacht (RAL 7016)**  
Für Außenmaß

300 x 300	350 x 350
<b>300009</b> €1229	<b>350009</b> €1248

Nutzlänge 2000 mm

 Bei Verwendung für einen Fremdschacht mit abweichenden Maßen, muss die Kopfverkleidung bauseits unterfüttert werden. Siehe auch Seite 51.

**Dacheindichtungsstreifen**

300 x 3000 mm schwarz



**242365**  
€155

**Schachtelement für Feuerstättenanschluss**

Innenmaß	200 x 200	250 x 250
<b>300004</b> €191	<b>350004</b> €208	

Nutzlänge 500 mm

**Schachtelement**

Außenmaß	300 x 300	350 x 350
Innenmaß	200 x 200	250 x 250
<b>300201</b> €80	<b>350251</b> €88	

Nutzlänge 500 mm

 PP-Innenrohre sind separat zu bestellen.

**Kleber, Verarbeitung bis -8°C**



ausreichend  
lfdm

**250900**  
€34

5,5      5,0

**Schachtelement mit Kamintür**

Innenmaß	200 x 200	250 x 250
<b>300003</b> €194	<b>350003</b> €221	

Nutzlänge 500 mm

**Bodenplatte**

Innenmaß	200 x 200	250 x 250
<b>300001</b> €70	<b>350001</b> €77	

Nutzlänge 50 mm

Mehrfachbelegung DN 80 und DN 110 Bajonett-System

Abdeckplatte für Kopfverkleidung  
(inkl. Mündungshaube)

DN 80	DN 110
250 x 250	300 x 300
<b>250080</b> €228	<b>300110</b> €287

Die Feuerstätten müssen bei Überdruckauslegung gegen rückströmende Abgase gesichert sein! ATEC bietet entsprechende Rückstromsicherungen als OEM-Artikel an.



Flyer Rückstromsicherung  
Art.Nr. 10003143

MFB Anschluss-Set PolyBit DN 60/100

DN 80	DN 110
<b>651370</b> €285	<b>653370</b> €303

MFB Anschluss-Set PolyBit DN 80/125

DN 80	DN 110
<b>651371</b> €285	<b>653371</b> €303

- (1) Eintauchstück
- (2) Schachtblende + Befestigungsset
- (3) Wandfutter + Inbusschraube
- (4) MFB T-Stück 87°

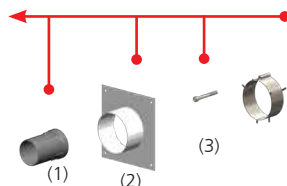

DN 80 und 110 Flexrohr als Stange separat bestellen siehe Seiten 41.

Kontroll-Rohr mit Kondensatablauf

DN 80	DN 110
<b>651349</b> €160	<b>653349</b> €197

- (1) Siphon und Kondensatschlauch 1,5 m
- (2) Kontroll-Rohr mit Kondensatablauf
- (3) Bajonettverschluss
- (4) Flexrohrhülse

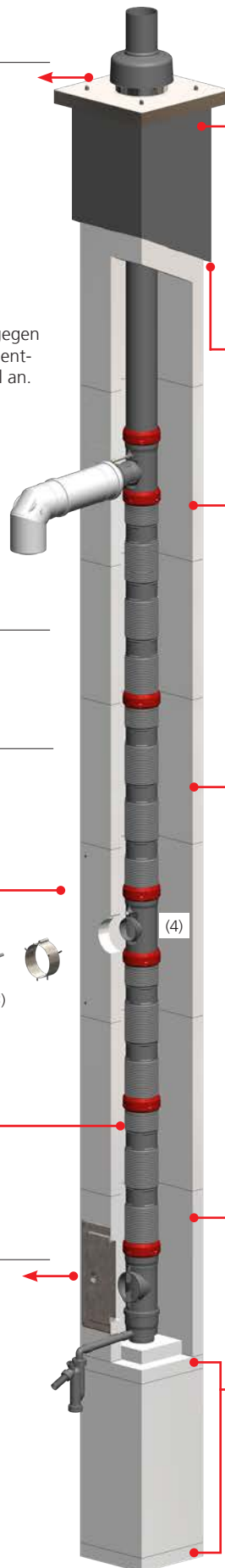
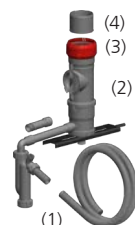

DN 80    DN 110

Kopfverkleidung für Schacht (RAL 7016)

Für Außenmaß 250 x 250    300 x 300

<b>250009</b> €983	<b>300009</b> €1229
-----------------------	------------------------

Nutzlänge 2000 mm

Bei Verwendung für einen Fremdschacht mit abweichenden Maßen, muss die Kopfverkleidung bauseits unterfüttert werden. Siehe auch Seite 51.

Dacheindichtungsstreifen

300 x 3000 mm schwarz



<b>242365</b> €155
-----------------------

Schachtelement für Feuerstättenanschluss

Innenmaß 150 x 150    200 x 200

<b>250004</b> €168	<b>300004</b> €191
-----------------------	-----------------------

Nutzlänge 500 mm

Schachtelement

Außenmaß 250 x 250    300 x 300

Innenmaß 150 x 150    200 x 200

<b>250151</b> €68	<b>300201</b> €80
----------------------	----------------------

Nutzlänge 500 mm

PP-Innenrohre sind separat zu bestellen.

Kleber, Verarbeitung bis -8°C



ausreichend lfdm

<b>250900</b> €34
----------------------

6,0

5,5

Schachtelement mit Kamintür

Innenmaß 150 x 150    200 x 200

<b>250003</b> €168	<b>300003</b> €194
-----------------------	-----------------------

Nutzlänge 500 mm

Bodenplatte

Innenmaß 150 x 150    200 x 200

<b>250001</b> €62	<b>300001</b> €70
----------------------	----------------------

Nutzlänge 50 mm

# MEHRFACHBELEGUNG

## A TEC | ABGASSYSTEME

### Mehrfachbelegung

Allgemeine Bauartgenehmigung Nr. Z-5.3356 für Gasgeräte



[Link zum Video](#)

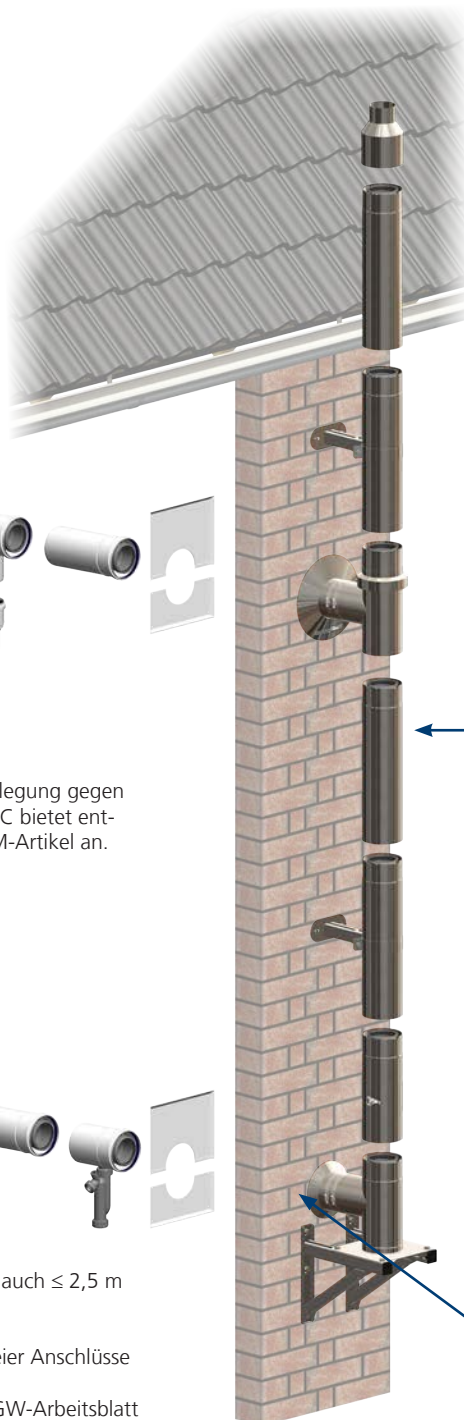

WhitePoly Sets und Bauteile ab Seite 24

IronPoly Sets und Bauteile ab Seite 26

← Kompensatorelement unter jeden Geräteanschluss



Die Feuerstätten müssen bei Überdruckauslegung gegen rückströmende Abgase gesichert sein! ATEC bietet entsprechende Rückstromsicherungen als OEM-Artikel an.



[Flyer Rückstromsicherung](#)  
Art.Nr. 10003143



#### Hinweis:

Die Abstände zwischen den Anschlüssen können auch  $\leq 2,5$  m sein wenn:

- Alle Geräte von einem Hersteller sind.
- Ein Nachweis für verminderte Abstände zweier Anschlüsse als Bauartprüfung C (11) vorliegt.
- Alle anderen Anforderungen nach dem DVGW-Arbeitsblatt G 635 erfüllt sind.

Vgl. auch DVGW-Arbeitsblatt, Ziffer 4.2.



Im Bereich der Wanddurchführung ist White/IronPoly zu verwenden.

DN 80/125 DN 100/150 DN 110/160 DN 125/190 DN 160/230

**Anschluss T-Stück für Mehrfachbelegung mit Zuluftansaugung (Edelstahl weiß)**



D80/125

Nutzlänge	<b>711704</b> €265	<b>712704</b> €318	<b>713704</b> €352
	275 mm	275 mm	318 mm

**Kompensatorelement (Edelstahl weiß)**



Nutzlänge	<b>711721</b> €142	<b>712721</b> €200	<b>713721</b> €237
	940 mm	940 mm	940 mm

**Anschlussbogen mit Zuluftansaugung (Edelstahl weiß)**



D80/125

Nutzlänge	<b>711734</b> €296	<b>712702</b> €318	<b>713702</b> €352
	86 mm	97 mm	101 mm

**Verankerungsplatte (Edelstahl weiß)**



Maße (mm)	<b>711733</b> €94	<b>712733</b> €97	<b>713733</b> €120
	195 x 195	195 x 195	235 x 235

**Anschluss T-Stück für Mehrfachbelegung mit Zuluftansaugung (Edelstahl blank)**



D80/125

Nutzlänge	<b>701704</b> €264	<b>702704</b> €317	<b>703704</b> €351	<b>704704</b> €424	<b>706704</b> €493
	275 mm	275 mm	318 mm	275 mm	445 mm

**Kompensatorelement (Edelstahl blank)**



Nutzlänge	<b>701721</b> €141	<b>702721</b> €199	<b>703721</b> €237	<b>704721</b> €276	<b>706721</b> €332
	940 mm	940 mm	940 mm	940 mm	940 mm

**Anschlussbogen mit Zuluftansaugung (Edelstahl blank)**



D80/125

Nutzlänge	<b>701734</b> €294	<b>702702</b> €317	<b>703702</b> €351	<b>704702</b> €380	<b>706702</b> €424
	86 mm	97 mm	101 mm	101 mm	134 mm

**Verankerungsplatte (Edelstahl blank)**



Maße (mm)	<b>701733</b> €94	<b>702733</b> €97	<b>703733</b> €120	<b>704733</b> €125	<b>706733</b> €128
	195 x 195	195 x 195	235 x 235	260 x 260	320 x 320

# ABGAS - SCHACHT

## A TEC | ABGASSYSTEME

Abgassystem mit Brandschutz L<sub>A</sub> 30, lieferbar in DN 60 und in DN 80 in **deckengestützter Bauweise** für den Anschluss von raumluftunabhängigen und raumluftabhängigen Gas- und Öl-Brennwertgeräten mit Abgastemperaturen ≤120 °C sowie BHKW-Anlagen mit Abgastemperaturen ≤100 °C. Schächte mit Schutzziel L<sub>A</sub> 90 siehe nächste Doppelseite. ☞ Die Innenrohre sind jeweils separat zu bestellen.

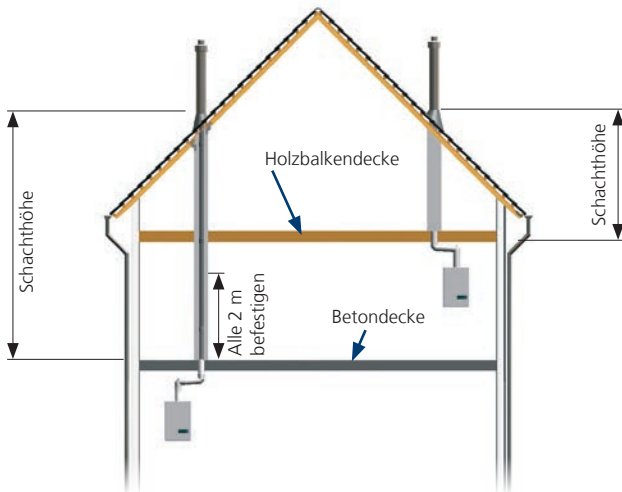

### Planungsweise:

Der Bedarf für PolyCase-Schächte errechnet sich **ab Oberkante Betondecke bzw. ab Unterkante Holzdecke bis Oberkante Dachpfanne**. Bei Bestellung eines **Kontroll-Rohr-Sets** sind **von der Schacht- und Abgasleitungshöhe 600 mm in Abzug** zu bringen.

Die Höhe der Dachhochführung beträgt für DN 60 und DN 80 650 mm und für DN 100 1.100 mm.

Beachten Sie bei der Dachhochführung die Dachstein- bzw. Ziegelfarbe.

Die Schächte sind alle 2 Meter an den Wänden gegen seitliches Verschieben mit Sicherungswinkel oder Wandbefestigungs-Sets zu befestigen. Die Deckendurchführung ist hierbei eine gleichwertige Führung.

Die Abgasanlagen können **ohne Brandsicherheitsabstände gegenüber brennbaren Baustoffen** eingebaut werden.

Bauelemente für Verbindungsleitungen bitte gemäß Preisliste Seite 18 (PolyClassic) oder Seite 19 (PolyTwin) bestellen.

### Basis-Set PolyCase für Beton-/ Holzdecken

- (1) Verankerungsplatte mit Anschlussrohr und Schelle
- (2) PP-Rohr 255 mm
- (3) 2 x Sicherungswinkel inkl. Spax-Schrauben

DN 60/100

**240370**  
€215

DN 80/125

**241370**  
€220

- (4) 1,0 kg Brandschutzkleber (ausreichend für 20 geschlossene Elemente oder 5 offene Elemente)
- (5) 3 x Abstandhalter
- (6) 4 x Alu-Verschlussketten

- (7) 6 x Tellerkopfschraube+Universaldübel

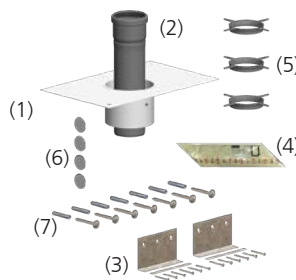

Weitere Sicherungswinkel und/oder Wandbefestigungs-Sets sind in Abhängigkeit der Schachthöhen und Wandabstände zusätzlich zu bestellen.

### Abstandhalter, Bedarf alle 2 - 3 m VPE 4 Stück

DN 60

**240353**  
€32

DN 80

**241353**  
€32



### 87°-Bogen mit Kontrollöffnung im Zuluftrohr

PP/Stahl weiß PP/PP weiß

DN 60/100

**240501**  
€67

DN 80/125

**241401**  
€111



	DN 60/L <sub>A</sub> 30	DN 80/L <sub>A</sub> 30
Außenmaß (mm)	150 x 200	150 x 200
Innenmaß (mm)	100 x 150	100 x 150

**Schachtelement 1.150 mm, inkl. Steckverbinder**

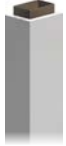

<b>241319</b> €212	<b>241319</b> €212
-----------------------	-----------------------

**Schachtelement 600 mm, inkl. Steckverbinder**



<b>241318</b> €139	<b>241318</b> €139
-----------------------	-----------------------

**30°-Schachtwinkel, einseitig offen, inkl. Steckverbinder**

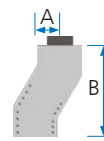

Versatzmaß A  
in mm B

<b>251314</b> €215	<b>251314</b> €215
112	112
417	417

**45°-Schachtwinkel, einseitig offen, inkl. Steckverbinder**

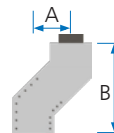
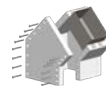

Versatzmaß A  
in mm B

<b>251315</b> €215	<b>251315</b> €215
179	179
432	432

**Kontroll-Rohr-Set**

1 x Kamintür      1 x Schachtelement 600 mm, einseitig offen, inkl. Steckverbinder  
1 x Kontroll-Rohr

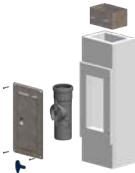

<b>240303</b> €419	<b>241303</b> €425
-----------------------	-----------------------

**Dachhochführung, konzentrisch, passend zur Schachtgröße**

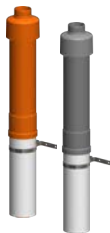

ziegelrot  
650 mm über Dach  
  
schwarz  
650 mm über Dach  
  
installierte Höhe

<b>240457</b> €193	<b>241457</b> €220
<b>240458</b> €193	<b>241458</b> €220
650 mm	650 mm



Flachdachkragen und Schrägdachpfannen siehe Seiten 22 und 23.

**Steckverbinder für Schachtbauteile als Ersatzteil**



<b>298038</b> €27	<b>298038</b> €27
----------------------	----------------------



Bei raumluftabhängiger Betriebsweise muß der Schacht durch die Dachhaut geführt werden und bei Innenrohr DN80 ein geeigneter Schacht aus dem L<sub>A</sub>90 Programm verwendet werden.

Abgassystem mit Brandschutz L<sub>A</sub> 90 in DN 80 und DN 100 in **deckengestützter Bauweise (Landesbaurecht beachten, Rücksprache mit dem bevollmächtigten Bezirksschornsteinfeger erforderlich)** sowie in DN 60 bis 250 in **bodengestützter Bauweise** für den Anschluss von raumluftunabhängigen und raumluftabhängigen Gas- und Öl-Brennwertgeräten mit Abgastemperaturen ≤120 °C sowie BHKW-Anlagen mit Abgastemperaturen ≤100 °C, Brandschutz L<sub>A</sub> 90. Die Innenrohre sind jeweils separat zu bestellen.

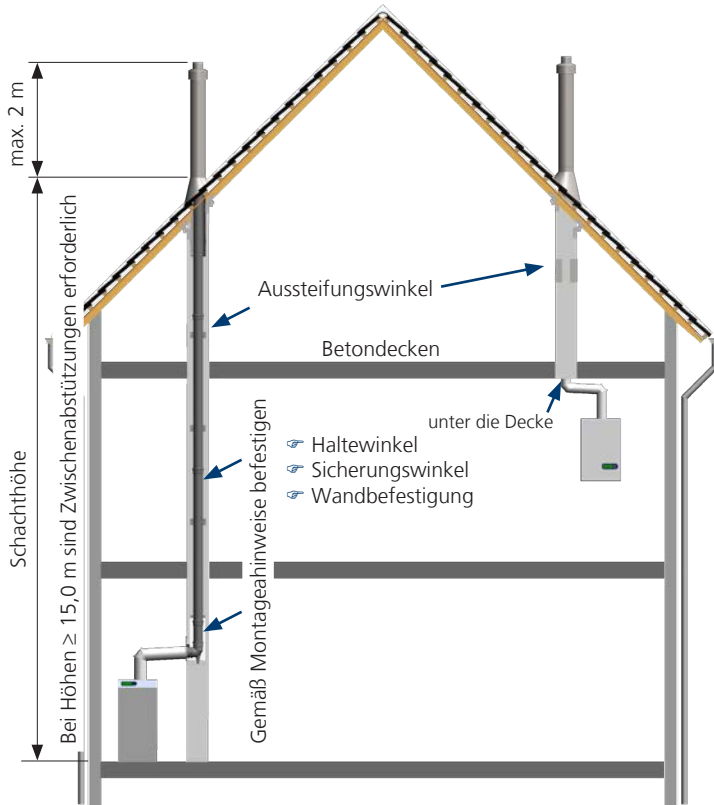

**Planungsweise:**

Deckengestützte Bauweise siehe bei Brandschutz L<sub>A</sub> 30.

Der Bedarf für PolyCase-Schächte errechnet sich **ab Oberkante Rohfußboden** im Heizgeräteaufstellraum **bis Oberkante Dachpfanne** **./.600 mm** für das **Schachtelement mit Feuerstättenanschluss**.

Bei Bedarf zusätzlicher Kontrollöffnungen im senkrechten Schachtabschnitt, sind **je Kontrollöffnung 600 mm Höhe von der Gesamtschachthöhe abzuziehen**.

Die Mündungshöhe über Dach kann ab DN 100 ohne Zusatzmaßnahmen bis zu 2,0 m betragen. Bei größeren Höhen sind zusätzliche, starre Abspannungen zur Windlastableitung erforderlich!

Die Schächte sind gemäß Montageanleitung, in den angegebenen max. Abständen (1,5 bis 3,0 m) an den Wänden und in den Decken gegen seitliches Verschieben mit Sicherungswinkeln oder Wandbefestigungs-Sets zu befestigen. Die Deckendurchführung ist hierbei eine gleichwertige Führung.

Die Abgasanlagen können **ohne Brandsicherheitsabstände** gegenüber brennbaren Baustoffen eingebaut werden.

Die bodengestützten Schächte erfüllen L<sub>A</sub> 90 Brandschutzziele. Bauelemente für Verbindungsleitungen bitte je nach Bedarf ab Seite 8 unter PolyTop, PolyClassic oder PolyTwin bestellen.

**Tab. PolyCase-Schachtgewichte**

DN	Schachtgewicht
60+80/L <sub>A</sub> 90	15,0 kg / stgm
100+110/L <sub>A</sub> 90	19,0 kg / stgm
125/L <sub>A</sub> 90	23,0 kg / stgm
160/L <sub>A</sub> 90	26,0 kg / stgm
200/L <sub>A</sub> 90	30,0 kg / stgm
250/L <sub>A</sub> 90	37,0 kg / stgm

**L<sub>A</sub> 90 Basis-Set PolyCase für Betondecken**

- (1) Verankerungsplatte mit Anschlussrohr und Schelle
- (2) PP-Rohr

DN 80/125	<b>241370</b> €220
DN 100/150	<b>242370</b> €419
DN 110/160	<b>243370</b> €505

- (3) 2 x Sicherungswinkel inkl. Spax-Schrauben
- (4) 1,0 kg Brandschutzkleber

- (5) 3 x Abstandhalter
- (6) 4 x Alu-Verschlussketten
- (7) 6 x Tellerkopfschraube+Universaldübel

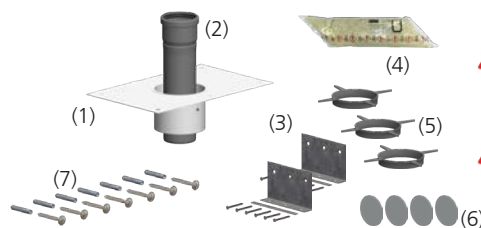

Weitere Sicherungswinkel und/oder Wandbefestigungs-Set sind in Abhängigkeit der Schachthöhen und Wandabstände zusätzlich zu bestellen.



Diese Anschlussart ist im Planungsstadium mit dem bevollmächtigten Bezirksschornsteinfeger abzustimmen.



**L<sub>A</sub> 90 Basis-Set PolyCase für Bodenmontage, DN 80 bis DN 250**

- (1) Sparrenhalter-Set PolyCase (kein Lieferumfang bei DN 60 und DN 80)
- (2) Schachtelement 600 mm für Anschluss der Feuerstätte inkl. ATEC-Schachteinführung
- (3) Wandblende für Gleich- und Gegenstrombetriebsweise

- (4) Bodenplatte
- (5) Aussteifungswinkel-Set
- (6) 1,0 kg Brandschutzkleber

DN 60	<b>240334</b> €580	<b>200 x 200</b>	<b>120 x 120</b>	680 mm
DN 80	<b>241334*</b> €644	<b>200 x 200</b>	<b>120 x 120</b>	680 mm
DN 100	<b>242334</b> €794	<b>240 x 240</b>	<b>160 x 160</b>	680 mm
DN 110	<b>243334*</b> 851	<b>240 x 240</b>	<b>160 x 160</b>	680 mm
DN 125	<b>244334</b> €939	<b>280 x 280</b>	<b>200 x 200</b>	680 mm
DN 160	<b>246334</b> €1008	<b>310 x 310</b>	<b>230 x 230</b>	680 mm
DN 200	<b>248334</b> €1174	<b>350 x 350</b>	<b>270 x 270</b>	680 mm
DN 250	<b>249334</b> €1328	<b>420 x 420</b>	<b>340 x 340</b>	680 mm

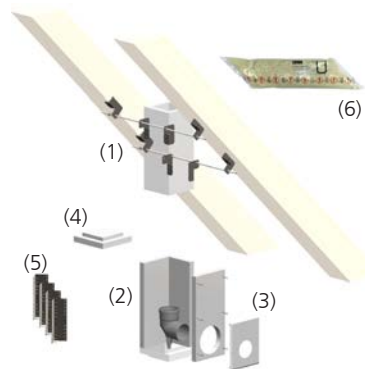

87°-Bogen mit Kontrollöffnung im Zulufrohr siehe Seite 46

Die Zuordnungen der Schachtabstände setzen eine strömungstechnische Berechnung nach EN 13384 für raumluftunabhängigen Betrieb voraus.

**\*Für raumluftabhängigen Betrieb müssen bei Abgasleitungen in DN 80 und 110, nach dem Baurecht, größere lichte Schächte notwendig werden.** In diesem Fall muss der Schacht durchgängig geführt werden.



Dachhochführung für DN 80 und DN 100 siehe Seite 50. Klebverbrauch siehe Seite 49.



	DN 60/L <sub>A</sub> 90	DN 100/L <sub>A</sub> 90	DN 125/L <sub>A</sub> 90	DN 160/L <sub>A</sub> 90	DN 200/L <sub>A</sub> 90	DN 250/L <sub>A</sub> 90
	DN 80/L <sub>A</sub> 90*	DN 110/L <sub>A</sub> 90*	*Bei raumluftabhängiger Betriebsweise nächstgrößeren Schacht verwenden.			
<b>Außenmaß (mm)</b>	200 x 200	240 x 240	280 x 280	310 x 310	350 x 350	420 x 420
<b>Innenmaß (mm)</b>	120 x 120	160 x 160	200 x 200	230 x 230	270 x 270	340 x 340

**Kontroll-Rohr-Set**

Kamintür

Schachtelement 600 mm, einseitig offen, inkl. Steckverbinder

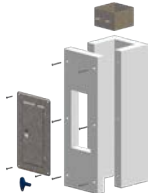

PP-Innenrohre sind separat zu bestellen.

<b>241403</b> €358	<b>242403</b> €403	<b>244403</b> €507	<b>246403</b> €557	<b>248403</b> €650	<b>249403</b> €846
-----------------------	-----------------------	-----------------------	-----------------------	-----------------------	-----------------------

Die Zuordnungen der Schachtquerschnitte setzen eine strömungstechnische Berechnung nach EN 13384 für raumluftunabhängigen Betrieb voraus. Für raumluftabhängigen Betrieb können bei Abgasleitungen in DN80 bis 110, nach dem Baurecht, größere lichte Schächte notwendig werden.

**Brandschutzkleber Inhalt 1 kg**

Kleberverbrauch bei 1,0 kg:



geschlossene Elemente (Stück)

einseitig offene Elemente (Stück)

	<b>239001</b> €26					
geschlossene Elemente (Stück)	19	15	12	11	9	8
einseitig offene Elemente (Stück)	4	4	3,5	3,5	3	3

**Schachtelement 1.195 mm, einseitig offen, inkl. Steckverbinder**

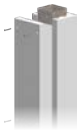

<b>251419</b> €331	<b>252419</b> €383	<b>254419</b> €436	<b>256419</b> €481	<b>258419</b> €535	<b>259419</b> €631
-----------------------	-----------------------	-----------------------	-----------------------	-----------------------	-----------------------

**Schachtelement 1.195 mm, inkl. Steckverbinder**



<b>241419</b> €309	<b>242419</b> €361	<b>244419</b> €414	<b>246419</b> €458	<b>248419</b> €513	<b>249419</b> €612
-----------------------	-----------------------	-----------------------	-----------------------	-----------------------	-----------------------

**Schachtelement 600 mm, inkl. Steckverbinder**



<b>241418</b> €182	<b>242418</b> €210	<b>244418</b> €242	<b>246418</b> €264	<b>248418</b> €292	<b>249418</b> €346
-----------------------	-----------------------	-----------------------	-----------------------	-----------------------	-----------------------

**30°-Schachtwinkel, einseitig offen, inkl. Steckverbinder**

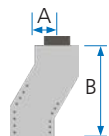
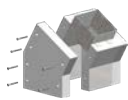

Versatzmaß A  
in mm B

	<b>251414</b> €234	<b>252414</b> €279	<b>254414</b> €296	<b>256414</b> €320	<b>258414</b> €347	<b>259414</b> €389
Versatzmaß A in mm	112	117	123	127	132	141
B	417	437	457	472	492	527

**45°-Schachtwinkel, einseitig offen, inkl. Steckverbinder**

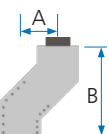
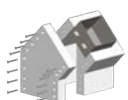

Versatzmaß A  
in mm B

	<b>251415</b> €234	<b>252415</b> €279	<b>254415</b> €295	<b>256415</b> €320	<b>258415</b> €347	<b>259415</b> €389
Versatzmaß A in mm	179	191	202	211	223	243
B	432	460	488	509	538	587

**Steckverbinder für Schachtbauteile als Ersatzteil**



<b>298039</b> €30	<b>298040</b> €32	<b>298041</b> €35	<b>298042</b> €37	<b>298043</b> €40	<b>298044</b> €46
----------------------	----------------------	----------------------	----------------------	----------------------	----------------------



Lieferzeit ab DN 125/L<sub>A</sub>90 für alle Bauteile 4 Wochen.

DN 60/100 DN 80/125 DN 100/150 DN 125/190 DN 160/215 DN 200/265 DN 250/315

**Mündungs-Set PolyCase DN 100 bis 250 (Edelstahl)**

(1) Mündungsabschluss 620 mm  
(2) Mündungslänge 940 mm

(ohne Innenrohr)  
(ohne Innenrohr)

(3) Schachtheadapter 1180 mm  
(4) 2 x Sparrenwinkel

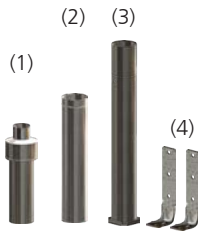

max. Inst. Höhe über Dach  
ohne weitere Abspannung

<b>242354</b> €865	<b>244354</b> €959	<b>246354</b> €1041	<b>248354</b> €1128	<b>249354</b> €1426
-----------------------	-----------------------	------------------------	------------------------	------------------------

1.600 mm	1.600 mm	1.600 mm	1.600 mm	1.600 mm
----------	----------	----------	----------	----------

**Mündungsverlängerung 940 mm L<sub>A</sub>90**



<b>242490</b> €108	<b>244490</b> €139	<b>246490</b> €152	<b>248490</b> €208	<b>249490</b> €231
-----------------------	-----------------------	-----------------------	-----------------------	-----------------------

**Flachdachdurchführung 0° - 5° inkl. Wetterkragen**



<b>704666</b> €243	<b>246666</b> €259	<b>708666</b> €369	<b>709666</b> €416
-----------------------	-----------------------	-----------------------	-----------------------

**Flexible Flachdachdurchführung bis 20° (inklusive Schrauben und Kleber)**

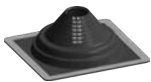

<b>701610</b> €255	<b>702610</b> €255
-----------------------	-----------------------

Grundfläche 270 x 290 mm

375 x 415 mm

Verwendbar für Blech-, Trapezblech und Faserzementdächer

**Dachdurchführung 6° - 32° inkl. Wetterkragen**



<b>702663</b> €373	<b>704768</b> €425	<b>706663</b> €439	<b>708663</b> €561	<b>709663</b> €609
-----------------------	-----------------------	-----------------------	-----------------------	-----------------------

**Dachdurchführung 33° - 45° inkl. Wetterkragen (steilere Dachneigung auf Anfrage)**



<b>702664</b> €373	<b>704769</b> €425	<b>706664</b> €439	<b>708664</b> €561	<b>709664</b> €609
-----------------------	-----------------------	-----------------------	-----------------------	-----------------------

**Blower door-Set**

Entsprechend gewünschtem Überdachabschluss  
Schacht mit Kopfverkleidung schützen oder  
bauseits entsprechend der Dachneigung bis  
Unterkante Dachdeckung kürzen

<b>241381</b> €224
-----------------------

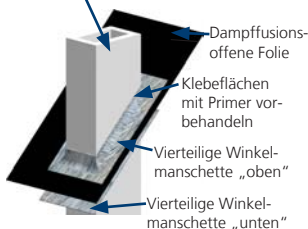

Verpackungsinhalt:  
Klebebandrolle Abmessung: B x L = 152,4 x 5710 mm  
Primer 250 mg

**Dachhochführung, konzentrisch, passend zu Schachtabmessungen**



ziegelrot	<b>240557</b> €188	<b>241557</b> €220	<b>242457</b> €380
schwarz	<b>240558</b> €188	<b>241558</b> €220	<b>242458</b> €380
inst. Höhe über Dach	650 mm	650 mm	1.100 mm



Nicht für raumluftabhängigen Betrieb geeignet





Flachdachkragen und Schrägdachpfannen siehe Seiten 22 und 23.



Lieferzeit ab DN 125/L<sub>A</sub>90 4 Wochen.

	DN 60	DN 80	DN 100	DN 125	DN 160	DN 200	DN 250
<b>Abstandhalter</b> , Bedarf alle 2 - 3 m							
4 Stück	240352 €32	241352 €32	242352 €41				
							
1 Stück				244352 €49	246352 €52	248352 €54	249352 €57
				ab DN 125 aus Edelstahl			

für alle DN

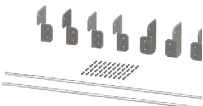

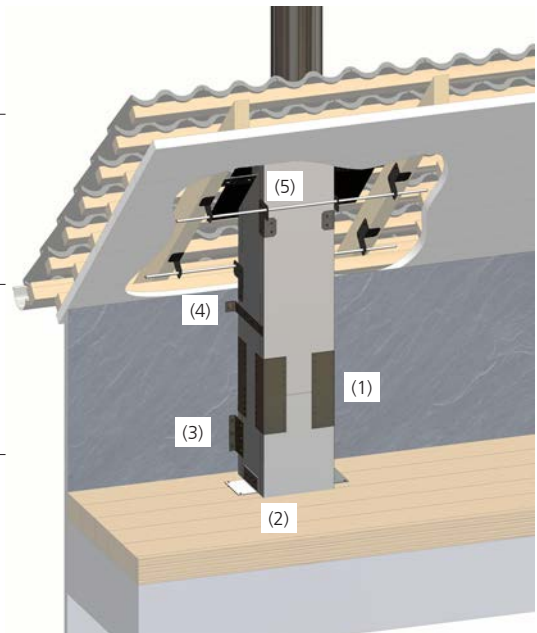
<b>Aussteifungswinkel-Set inkl. 80 Spax-Schrauben</b> (300 mm lang)							
(1)		249904 €128					
<b>Haltewinkel inkl. Schrauben</b>							
(2)	80 x 60 x 150 mm	249905 €101					
<b>Sicherungswinkel inkl. Schrauben</b> , für Wandabstände < 20 mm, für verdeckte und seitliche Montage							
(3)		129902 €31					
<b>Wandbefestigungs-Set</b> , für Wandabstände > 20 mm							
(4)	40 x 300 mm	249903 €38					
<b>Sparrenhalter-Set</b>							
(5)		129901 €136					



Mögliche Verwendung der Winkel

	DN 60/L <sub>A</sub> 90	DN 80/L <sub>A</sub> 90	DN 100/L <sub>A</sub> 90	DN 110/L <sub>A</sub> 90	DN 125/L <sub>A</sub> 90	DN 160/L <sub>A</sub> 90	DN 200/L <sub>A</sub> 90	DN 250/L <sub>A</sub> 90
<b>Für Außenmaß des Schachtes (mm)</b>	200 x 200	200 x 200	240 x 240	240 x 240	280 x 280	310 x 310	350 x 350	420 x 420

<b>Abdeckplatte für Kopfverkleidung (inkl. Mündungshaube)</b>								
	200060 €234	250080 €228	250100 €257	250110 €282	300125 €302	350160 €329	350200 €349	420250 €387
	Abdeckplatte Edelstahl, Mündungshaube PP							

<b>Kopfverkleidung</b>								
	200009 €890	200009 €890	250009 €983	250009 €983	300009 €1229	350009 €1248	350009 €1248	420009 €1377
	Nutzlänge 2000 mm							
	 Bei Verwendung für einen Fremdschacht mit abweichenden Maßen, muss die Kopfverkleidung bauseits unterfüttert werden. Siehe auch Seite 43.							
	Außen Aluminium Anthrazitgrau							

 Lieferzeit ab DN 125/L<sub>A</sub> 90 4 Wochen.

# ABGAS – WÄRMETAUSCHER

**ATEC | ABGASSYSTEME**

## Abgaswärmetauscher GPH AK

**Abgaswärmetauscher GPH AK 28**  
raumlufatabhängig



Link zum Video

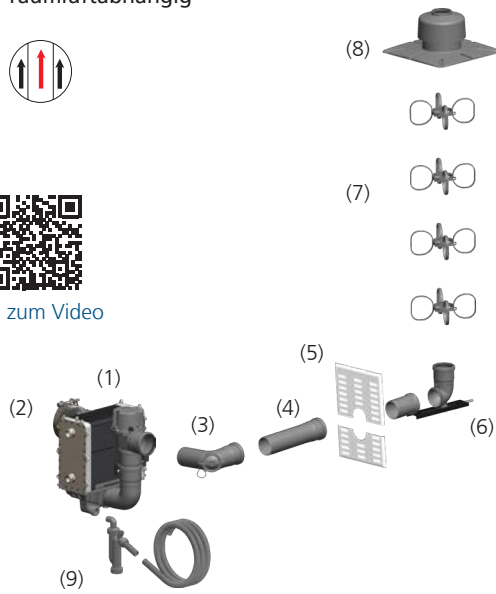

### eMAX Abgaswärmetauscher GPH AK 28 Set

- (1) Wärmetauscher inkl. Abgasgebläse und Sicherungseinrichtung
- (2) Kesseladapter Ø 130 mm
- (3) 87°-Kontroll-Bogen DN 80
- (4) Rohr 500 mm DN 80
- (5) Wandblende mit Hinterlüftung DN 80
- (6) SV-Schachteinführung mit Auflager DN 80
- (7) Abstandhalter DN 80, 4x
- (8) Mündungs-Set DN 80
- (9) Siphon

Mündungs-Set aus Kunststoff GPH AK 28 kW

**801001**  
€2004

Mündungs-Set aus Edelstahl GPH AK 28 kW

**801003**  
€2148

**Kesseladapter Ø 150 mm inkl. Dichtung und Spannschelle**

**801034**  
€171

bedingt raumlufunabhängig

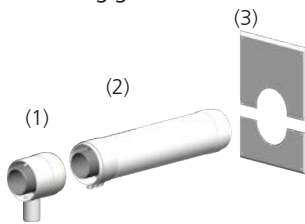

### Ergänzungs-Set GPH für Zuluftansaugung über den Schacht

- (1) Adapter für Zuluftansaugung (Anschluss 50 mm, Verbindung zum Brenner -> bauseits) DN 80/125
- (2) Rohr 500 mm DN 80/125
- (3) Wandblende geschlossen DN 80/125

GPH AK 28 kW

PolyTwin

**801110**  
€154

## Abgaswärmetauscher GPH AK 50 und 75

### eMAX Abgaswärmetauscher inklusive Abgasgebläse

GPH AK 50

**802004**  
€2775



Kesseladapter und Reduktion/Erweiterung separat bestellen.

GPH AK 75

**803004**  
€3896

### Kesseladapter inkl. Dichtung und Spannschelle

Ø 130	<b>802030</b> €173
Ø 150	<b>802031</b> €191
Ø 180	<b>802032</b> €208
Ø 200	<b>802033</b> €225

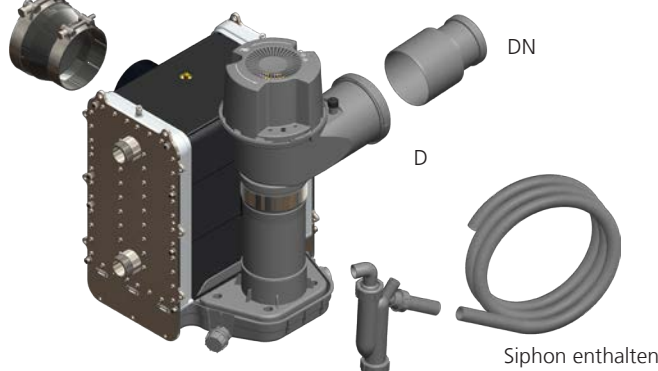

### Reduktion

D 110/DN 80	<b>1142</b> €43
D 110/DN 100	<b>2232</b> €51

### Erweiterung

D 110 _ DN 125	<b>4103</b> €77
----------------	--------------------

Siphon enthalten

## Abgaswärmetauscher GPH HP

Der GPH HP ist ein Abgaswärmetauscher für Blockheizkraftwerke bis 5000 Pa Förderdruck.



### eMAX Hochdruck-Abgaswärmetauscher bis 5.000 Pa

- 4 x Heizungsanschluß R 1" AG
- Feuerstättenanschluss (Stutzen da 60 mm)
- Abgasmuffe DN80
- Revisionsdeckel
- Heizungs-Entlüfter manuell
- Kondensatablauf 1" AG; Schlauch 21i/25a mm
- Siphon mit Sperrkugel, mit Auslauf D40
- ohne Abgastemperaturbegrenzer

Typ eMAX GPH HP 28

**801015**  
€ 1972



Für den sicheren Betrieb ist ein Abgastemperaturbegrenzer einzusetzen.

#### Verlängerung (kürzbar)

GPH AK 28

**801021**  
€ 38



Baulänge:  
250 mm

#### Z-Verlängerung

GPH AK 28

**801031**  
€ 202



Seitlicher Versatz:  
100 mm  
Baulänge:  
150 mm

#### Kondensatbox, bis 30 kW, für Gas- oder Öl-Brennwert, inklusive Füllung

**601129**  
€ 144



Kann bei schwefelarmen Öl und Gas entfallen, Vorgaben der unteren Wasserbehörde beachten.

#### Standfuß

GPH AK/HP 28

**801080**  
€ 361



GPH AK/HP 50  
GPH AK/HP 75

**801081**  
€ 437

#### Ersatz Gebläserad

GPH AK 28

**801823**  
€ 22

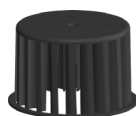

GPH AK 50

**816091**  
€ 57

GPH AK 75

**816103**  
€ 52

#### Flansch + Dichtung mit 1 Zoll AG für Wolf/Viessmann

(ältere Kessel)

**801041**  
€ 37



#### Flexschlauch Anbindung

GPH AK/HP 28

**801042**  
€ 37

Baulänge: 300 mm

GPH AK/HP 28

**801043**  
€ 28



450 mm

Überwurfmutter: G1

#### Winkelverschraubung G1 AG x G1 ÜM

**801051**  
€ 20



#### Wartungs-Set

GPH AK/HP 28

**801070**  
€ 35



GPH AK/HP 50  
GPH AK/HP 75

**801071**  
€ 39

#### Siphon-Set

GPH AK/HP 28,  
GPH AK/HP 50  
GPH AK/HP 75

**801060**  
€ 43



#### Abgastemperaturbegrenzer-ATB-Set

für die

**DN 80**

**DN 110**

GPH HP 28

**601602**  
€ 510

GPH HP 50,  
GPH HP 75 zwingend!

**601604**  
€ 590



## Kraftschluss-Manschetten

Zum einfachen Anschluss unterschiedlicher Durchmesser bis zu 43 mm von z.B. PP-Rohren an Kesselstützen, Edelstahl-Schalldämpfer oder Edelstahl-Rohre, für Brennwertanlagen geeignet. Darüber hinaus können mit den Kraftschluss-Manschetten alle runden Rohrverbindungen dauerhaft und dicht im Indoor- und Outdoorbereich verbunden werden.

### Kraftschluss-Manschette



Preisgruppe 15

601421	601422	601423	601424	601425	601426	601427
€105	€127	€138	€171	€193	€275	€319

Spannbereich in mm:	40-65	50 - 80	75-110	100-133	123-161	160 - 192	183 - 226
Gesamtlänge in mm:	85	85	85	130	130	130	130
Nutzlänge in mm:	0	0	0	0	0	0	0

Temperaturbeständig bis 120°C  
Überdruckdicht bis 150.000 Pa = 1,5 bar

# SCHALLDÄMPFER

## Schalldämpferprogramm Neuheiten und Highlights

### ■ Unterschiedliche Dämpfetechniken

Das umfangreiche Schalldämpfer-Programm beinhaltet verschiedene Dämpfetechniken wie Absorption, Reflexion und Resonanz. Eine Schallpegelminderung kann somit bereits ab 40 Hz erzielt werden.

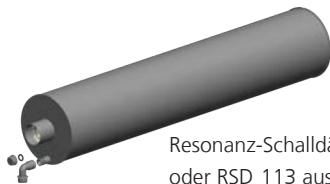

Resonanz-Schalldämpfer RSD 110  
oder RSD 113 aus PP

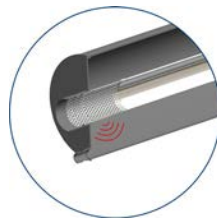

### ■ Kombi für breite Schalldämpfung

Darüber hinaus kann mit einer Kombination aus den neuen Resonanz-Schalldämpfern RSD 110 oder RSD 113 und einem Absorptions-Schalldämpfer ASD eine sehr breitbandige Dämpfung ohne nennenswerten Druckverlust ermöglicht werden.



Resonanz-Schalldämpfer RSD-FL 113  
mit Alu-Flansch aus Edelstahl

Das Schalldämpferprogramm finden Sie in unserer separaten **Preisliste (Art. Nr. 10003680)** auf unserer Homepage im Downloadbereich. Fordern Sie diese gerne an oder fragen Sie unsere Fachberatung.



# EDELSTAHL-SYSTEME

## ATEC Abgassysteme aus Edelstahl

- **Sanierung (Einwandige Systeme)**
- **Neubau (Doppelwandige Systeme)**
- **Objekte (Durchmesser bis 600 mm)**

Unsere Edelstahlsysteme sind vielseitig einsetzbar und bieten eine hohe Flexibilität auch für die Realisierung schwieriger Einbausituationen. Hiermit bietet ATEC nun auch eine Lösung für die Beheizung mit festen Brennstoffen, wie z.B. mit Pellets.

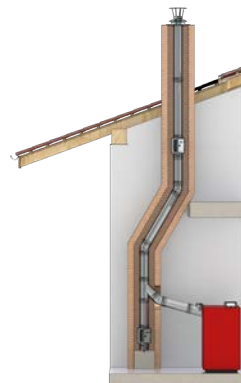

Das umfangreiche Edelstahlprogramm finden Sie in unserer separaten **Preisliste (Art.Nr. 10001479)** auf unserer Homepage im Downloadbereich. Fordern Sie diese gerne an oder fragen Sie unsere Fachberatung.





Wir bitten um Zusendung folgender Unterlagen:

Absender:

\_\_\_\_\_ Stück Preisliste(n)

Anlage bereits installiert: DN \_\_\_\_\_

**Angebot/Materialaufstellung**

**Querschnittsberechnung nach DIN EN 13384**

Postleitzahl und Einbauort der Feuerstätte: \_\_\_\_\_

Hersteller der Feuerstätte: \_\_\_\_\_

Typ: \_\_\_\_\_

Leistung: \_\_\_\_\_  Anzahl der Feuerstätten

Betriebsweise:  raumluftabhängig  Mehrfachbelegung  Kondensatabführung üb. Schacht  
Abstände zwischen den Geräten: \_\_\_\_\_ m  
Abstand oberstes Gerät bis Mündung: \_\_\_\_\_ m  
 raumluftunabhängig  Kaskade

Umlenkungen in der Verbindungsleitung: \_\_\_\_\_ x 87°-Kontroll-Bogen

\_\_\_\_\_ x 87°-Bogen

\_\_\_\_\_ x 45°-Bogen

\_\_\_\_\_ x 30°-Bogen

Gestreckte Länge der Verbindungsleitung: \_\_\_\_\_ m

Gestreckte Länge der Steigleitung: \_\_\_\_\_ m

Kontrollöffnung im Dachgeschoss:  ja

Schachtgröße (mm): Ø \_\_\_\_\_ x \_\_\_\_\_

Mündungsset aus Edelstahl:  ja

Rohr flexibel:  ja

Schachtsystem PolyCase:  ja  L<sub>A</sub>30  L<sub>A</sub>90

Außenwandmontage WhitePoly:  ja Wandabstand: \_\_\_\_\_ mm

Außenwandmontage IronPoly:  ja Wandabstand: \_\_\_\_\_ mm

Sonderoberfläche:  ja \_\_\_\_\_

Skizze:

Datum: \_\_\_\_\_

Kunden-Kommission: \_\_\_\_\_

Kunden-Bestell-Nummer: \_\_\_\_\_

Zuständig: \_\_\_\_\_

Termin: \_\_\_\_\_

# Übersicht Heizgeräte – Abgasquerschnitte – max. Leitungslängen

Der Durchmesser der Abgasführung ergibt sich aus:

1. der eingesetzten Feuerstätte mit benötigter Leistung
2. Umlenkungen im Verbindungsstück
3. Summe der gestreckten Länge der Verbindungsstück und Steigleitung
4. raumluftabhängiger oder raumluftunabhängiger Betriebsweise
5. vorhandenen lichten quadratischen/gleichwertigen hydraulischen Schachtabmessungen

Zur Vereinfachung der Querschnittsbestimmung sind in der Übersicht folgende Rahmenbedingungen berücksichtigt:

• Schachtmaße:	DN 60	Ø 135 mm	▣ 115 x 115 mm
	DN 80	Ø 154 mm	▣ 134 x 134 mm
	DN 100	Ø 175 mm	▣ 155 x 155 mm
	DN 110	Ø 188 mm	▣ 168 x 168 mm
	DN 125	Ø 206 mm	▣ 186 x 186 mm
	DN 160	Ø 244 mm	▣ 224 x 224 mm
	DN 200	Ø 282 mm	▣ 262 x 262 mm
	DN 250	Ø 334 mm	▣ 314 x 314 mm

- gestreckte Länge der Verbindungsleitung 1,5 m
- Umlenkungen in der Verbindungsleitung: 2 x 87°

Die Schachtmaße können bei raumluftunabhängiger Betriebsweise je nach Kesseltyp auch geringer sein.

Bei zusätzlichen Umlenkungen verringert sich die gestreckte Baulänge um:

- 0,3 m je 30°-Bogen
- 0,5 m je 45°-Bogen
- 0,8 m je 87°-Bogen

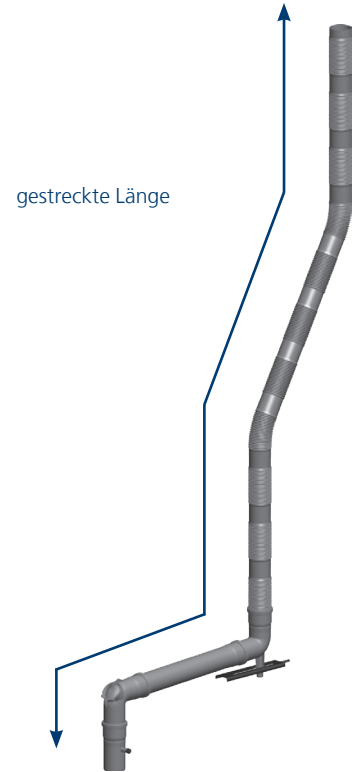

Hersteller / Typ	Anschlussstück Kesselhersteller	ATEC Anschlussadapter		Verbindungs- leitung	Steigleitung einwandig	Schacht	
		gerade	87°-Bogen			konzentrisch	Außenwandmontage
ABC	xxxxxx	1220	1219	80	80 - 20(16)		80/125 - 16
Hersteller	Gibt an, ob ein Messelement oder Adapter vom Kesselhersteller eingesetzt werden muss	Gerades Kesselanschlussbauteil/Übergang	87°-Kesselanschlussbauteil/Übergang	DN 80 = Durchmesser des Verbindungsstücks	DN 80 = Durchmesser der Steigleitung  20 = maximale gestreckte Länge der Abgasführung in m  (16) = maximale gestreckte Baulänge der Abgasführung bei Einsatz von flexiblem Rohr in m	im Gebäude senkrecht im Schacht	16 = maximale gestreckte Länge der Abgasführung. Zulufansaugung nach max. 2 m

## Dimensionierung

Alle aufgeführten Baulängen beziehen sich auf die gestreckte Länge der Abgasführung, welche nach EN 13384 ermittelt wurde. Bei Einsatz von flexiblen Rohren gelten die Werte in Klammern ( ). Die Temperaturbedingungen wurde nicht berücksichtigt.

Technische Änderungen der Kesselhersteller vorbehalten. Die Planungs- und Ausführungshinweise für die Heizgeräte sind zu beachten.





ATAG	Anschlussstück Kesselhersteller	ATEC Anschlussadapter gerade	Verbindungs- leitung	Steigleitung einwandig	Außenwandmontage	
<b>raumluftabhängig</b>						
A244 EC	-	-	80	80-28(24)	-	80/125-28
i24SZ	-	-	80	80-30(30)	-	80/125-30
i28CZ / ECZ	-	-	80	80-30(30)	-	80/125-30
i35SZ	-	-	80	80-30(30)	-	80/125-30
i36ECZ	-	-	80	80-30(30)	-	80/125-30
Q15SR	-	-	80	80-30(30)	-	80/125-30
Q25SR / Q25 CR Kombi	-	-	80	80-29(26)	-	80/125-29
Q38 SR / CR	-	-	80	80-24(21)	100-30(30)	80/125-24 100/150-30
Q50SR	-	-	80	80-13(11)	100-30(30)	80/125-13 100/150-30
Q60SR	RX102020	1146 €43	100	100-30(30)	-	100/150-30
XL75 W / F	-	-	100	100-30(30)	-	100/150-30
XL105 W / F	-	3151 €59	100	100-28(24)	-	100/150-26
XL125 W / F	-	3151 €59	100	100-7(6)	110-14(13)	100/150-7 110/160-14
XL150 W / F	-	3151 €59	100	100-7(6)	125-30(30)	100/150-6 125/190-30
XL180 W / F	-	4106 €124	125	125-25(23)	-	125/190-25
XL210 W / F	-	4106 €124	125	125-21(20)	-	125/190-21



ATAG	Anschlussstück Kesselhersteller	ATEC Anschlussadapter gerade	Verbindungs- leitung	Steigleitung einwandig	konzentrisch	Außenwandmontage
<b>raumluftunabhängig</b>						
A244 EC	-	-	80/125	80-15(13)	100-30(30)	80/125-10 80/125-27
i24SZ	-	-	80/125	80-30(30)	-	80/125-28 80/125-30
i28CZ / ECZ	-	-	80/125	80-30(30)	-	80/125-30 80/125-30
i35SZ	-	-	80/125	80-30(30)	-	80/125-30 80/125-30
i36ECZ	-	-	80/125	80-29(26)	100-30(30)	80/125-22 80/125-30
Q15SR	-	-	80/125	80-30(30)	-	80/125-30 80/125-30
Q25SR / Q25 CR Kombi	-	-	80/125	80-18(16)	-	80/125-14 80/125-30
Q38 SR / CR	-	-	80/125	80-11(10)	100-30(29)	80/125-8 80/125-23
Q50SR	-	-	80/125	80-6(6)	100-19(18)	80/125-4 80/125-12
Q60SR	RX103020	2266 €97	100/150	100-16(15)	-	100/150-13 100/150-30
XL75 W / F	-	-	100/150	100-20(18)	-	100/150-30
XL105 W / F	-	-	100/150	100-14(13)	110-24/22	100/150-8 100/150-23
XL125 W / F	-	3151 €59	100/150	100-4(4)	125-9(9)	- 110/160-5
XL150 W / F	-	-	auf Anfrage	-	-	-
XL180 W / F und XL210 W / F	-	-	auf Anfrage	-	-	-



BOSCH (JUNKERS)	Anschlussstück Kesselhersteller	ATEC Anschlussadapter gerade	Verbindungs- leitung	Steigleitung einwandig	Außenwandmontage	
<b>raumluftabhängig</b>						
CSW 14/75-3 Cerapur Solar-Comfort	-	-	80	80-30(30)	-	80/125-30
CSW 24/75-3 Cerapur Solar-Comfort	-	-	80	80-30(30)	-	80/125-30
GC 5300i WM 17/100 S 21/23	-	-	80	80-30(30)	-	80/125-30
GC 5300i WM / WMA 24/100 - 24/210 S 21/23	-	-	80	80-30(30)	-	80/125-30
GC 5700i WT 24/42 S23	-	-	80	80-30(30)	-	80/125-30
GC 5800iW 14P / 24P	-	-	80	80-30(30)	-	80/125-30
GC 7000F 15 / F 22 / F 30 / F 40	-	-	80	80-30(30)	-	80/125-30
GC 7000F 50	-	-	80	80-24(21)	100-30(30)	80/125-24 100/150-30
GC 7000F 75	-	2232 €51	100	100-30(30)	-	100/150-30
GC 7000F 100	-	2232 €51	100	100-19(16)	-	100/150-19
GC 7000F 150	-	6115 €75	160	160-30(30)	-	160/230-30
GC 7000F 200	-	8115 €77	200	200-30	-	200/265-30 160/230-30
GC 7000F 250	-	8115 €77	200	200-30	160-30	200/265-30 160/230-30
GC 7000F 300	-	8115 €77	200	200-30	-	200/265-30
GC 7000iW 14	-	0130 €32	60	60-30(30)	-	60/100-30
GC 7000iW 24 / 24 B / 24 BC / 24 C	-	-	80	80-30(30)	-	80/125-30
GC 7000iW 28 C / 28 BC	-	-	80	80-30(30)	-	80/125-30
GC 7000iW 35 C / 35 BC	-	-	80	80-30(30)	-	80/125-30
GC 7000iW 42 / 42 B	-	-	80	80-30(30)	-	80/125-30
GC 7000WP 70 23	-	2232 €51	100	100-30(30)	-	100/150-30
GC 7000WP 100 23	-	2232 €51	100	100-27(24)	-	100/150-27
GC 7800iW 15 / 20/24	-	-	80	80-30(30)	-	80/125-30
GC 7800iW 25 / 20/30	-	-	80	80-30(30)	-	80/125-30
GC 7800iW 30/35	-	-	80	80-30(29)	-	80/125-29
GC 7800iW 40	-	-	80	80-30(26)	-	80/125-26
GC 8000i F 15 / F 22 / F 30 / F 40	-	-	80	80-30(30)	-	80/125-30
GC 8000i F 50	-	-	80	80-23(20)	100-30(30)	80/125-23 100/150-30
GC 9000iWM 20/100 - 20/210 S / SB 23	-	-	80	80-30(30)	-	80/125-30
GC 9000iWM 30/100 - 30/210 S / B / SB	-	-	80	80-30(30)	-	80/125-30
GC 9000iW 40	-	-	80	80-30(30)	-	80/125-30
GC 9000iW 50	-	-	80	80-17(15)	100-30(30)	80/125-17 100/150-30
GC 9001iW 20E / 20EB / 20H	-	-	80	80-30(30)	-	80/125-30
GC 9800iW 20P / 20H / 30P / 30H / 40H	-	-	80	80-30(30)	-	80/125-30
GC 9800iW 50H	-	-	80	80-30(29)	-	80/125-29
ZWSB-22/28 Cerapur/Acu	-	-	80	80-30(30)	-	80/125-30
ZBR 70-3A Cerapur Maxx	-	-	100	100-30(30)	-	100/150-30
ZBR 100-3A Cerapur Maxx	-	3151 €59	100	100-29(25)	110-30(30)	100/150-29
ZBS 14/100 S-3 MA Cerapur/Modul	-	-	80	80-30(30)	-	80/125-30
ZBS 22/75 S-3 MA Cerapur/Modul	-	-	80	80-30(30)	-	80/125-30
ZBS 22/100 S-3 MA Cerapur/Modul	-	-	80	80-30(30)	-	80/125-30
ZBS 30/150 S-3 MA Cerapur/Modul	-	-	80	80-30(30)	-	80/125-30
ZSB 14-5.2 C	-	-	60	60-30(30)	-	60/100-30
ZSB 24-5 C Cerapur	-	-	80	80-30(30)	-	80/125-30
ZWB 24-5 C	-	-	80	80-30(30)	-	80/125-30
ZWB 28-5 C	-	-	80	80-30(30)	-	80/125-30
OC 7000F 18	-	1115 €33	80	80-30(30)	-	80/125-30

**Fortsetzung Bosch (Junkers) raumluftunabhängig**

OC 7000F 22	-	1115 €33	-	80	80-30(28)	100-30(30)	-	80/125-30	-
OC 7000F 30	-	1115 €33	-	80	80-15(13)	100-30(30)	-	80/125-15	100/150-30
OC 7000F 35	-	1115 €33	-	80	80-17(15)	100-30(30)	-	80/125-17	100/150-30
OC 7000F 49	-	1166 €55+2115 €44	-	100	100-30(30)	-	-	100/150-30	-
OC 8000iF 19 - 19/120	-	1115 €33	-	80	80-30(30)	-	-	80/125-30	-
OC 8000iF 27 - 25/120	-	1115 €33	-	80	80-30(30)	-	-	80/125-30	-



<b>BOSCH (JUNKERS)</b>	<b>Anschlussstück Kesselhersteller</b>	<b>ATEC Anschlussadapter gerade</b>	<b>Verbindungsleitung</b>	<b>Steigleitung einwandig</b>	<b>konzentrisch</b>	<b>Außenwandmontage</b>
<b>raumluftunabhängig</b>						
CSW 14/75-3 Cerapur Solar-Comfort	-	-	80/125	80-30(30)	80/125-30	80/125-30
CSW 24/75-3 Cerapur Solar-Comfort	-	-	80/125	80-27(24)	100-30(30)	80/125-15
GC 5300i WM 17/100 S 21/23	-	1884 €20	80/125	80-30(30)	-	80/125-30
GC 5300i WM / WMA 24/100 - 24/210 S 21/23	-	1884 €20	80/125	80-30(30)	-	80/125-30
GC 5700i WT 24/42 S23	-	1884 €20	80/125	80-30(30)	-	80/125-22
GC 5800iW 14P / 24P	-	-	80/125	80-30(30)	-	80/125-30
GC 7000F 15	-	1884 €20	80/125	80-30(30)	-	80/125-30
GC 7000F 22	-	1884 €20	80/125	80-30(23)	-	80/125-25
GC 7000F 30	-	1884 €20	80/125	80-27(25)	100-30(30)	80/125-19
GC 7000F 40	-	1884 €20	80/125	80-20(19)	100-30(30)	80/125-14
GC 7000F 50	-	1884 €20	80/125	80-13(12)	100-30(30)	80/125-9
GC 7000F 75	-	3884 €25	110/160	100-14(14)	-	100/150-11
GC 7000F 100	-	3884 €25	100/150	100-7(6)	-	100/150-5
GC 7000iW 14	-	0866 €61	80/125	60-29(27)	-	60/100-22
GC 7000iW 24 / 24 B / 24 BC / 24 C	-	-	80/125	80-30(30)	-	80/125-30
GC 7000iW 28 C / 28 BC	-	-	80/125	80-30(30)	-	80/125-30
GC 7000iW 35 C / 35 BC	-	-	80/125	80-19(18)	100-30(30)	80/125-14
GC 7000iW 42 / 42 B	-	-	80/125	80-20(18)	100-30(30)	80/125-14
GC 7000WP 70 23	-	2221 €123	100/150	100-22(20)	-	100/150-12
GC 7000WP 100 23	-	2221 €123	100/150	100-13(12)	-	100/150-21
GC 7800iW 15 / 20/24	-	-	80/125	80-30(30)	-	80/125-30
GC 7800iW 25 / 20/30	-	-	80/125	80-30(30)	-	80/125-27
GC 7800iW 30/35	-	-	80/125	80-24(21)	-	80/125-15
GC 7800iW 40	-	-	80/125	80-21(18)	100-30(30)	80/125-13
GC 8000i F 15	-	-	80/125	80-30(30)	-	80/125-30
GC 8000i F 22	-	-	80/125	80-30(30)	-	80/125-29
GC 8000i F 30	-	-	80/125	80-26(24)	-	80/125-18
GC 8000i F 40	-	-	80/125	80-20(18)	-	80/125-14
GC 8000i F 50	-	-	80/125	80-13(12)	100-30(30)	80/125-9
GC 9000iWM 20/100 - 20/210 S / SB 23	-	-	80/125	80-30(30)	-	80/125-24
GC 9000iWM 30/100 - 30/210 S / B / SB	-	-	80/125	80-30(30)	-	80/125-24
GC 9000iW 40	-	-	80/125	80-22(20)	100-30(30)	80/125-14
GC 9000iW 50	-	-	80/125	100-24(23)	-	80/125-6
GC 9001iW 20E / 20EB / 20H	-	-	80/125	80-30(30)	-	80/125-24
GC 9800iW 20P / 20H / 30P / 30H / 40H	-	-	80/125	80-30(30)	-	80/125-30
GC 9800iW 50H	-	-	80/125	80-30(29)	-	80/125-26
ZWSB-22/28 Cerapur/Acu	-	1884 €20	80/125	80-24(22)	-	80/125-17
ZBR 70-3A Cerapur Maxx	-	3268 €84	100/150	100-17(16)	-	100/150-13
ZBR 100-3A Cerapur Maxx	-	3268 €84	100/150	100-17(16)	110-30(29)	100/150-15
ZBS 14/100 S-3 MA Cerapur/Modul	-	-	80/125	80-30(30)	-	80/125-30
ZBS 22/75 S-3 MA Cerapur/Modul	-	-	80/125	80-22(20)	-	80/125-15
ZBS 22/100 S-3 MA Cerapur/Modul	-	-	80/125	80-22(20)	-	80/125-15
ZBS 30/150 S-3 MA Cerapur/Modul	-	-	80/125	80-19(18)	-	80/125-13
ZSB 14-5.2 C	-	-	60/100	60-30(30)	-	60/100-25
ZSB 24-5 C Cerapur	-	1884 €20	80/125	80-30(30)	-	80/125-26
ZWB 24-5 C	-	1884 €20	80/125	80-30(30)	-	80/125-30
ZWB 28-5 C	-	1884 €20	80/125	80-30(30)	-	80/125-29
OC 7000F 18	-	1820 €72	80/125	80-25(24)	-	80/125-18
OC 7000F 22	-	1820 €72	80/125	80-14(13)	100-30(30)	80/125-9
OC 7000F 30	-	1820 €72	80/125	100-17(16)	-	80/125-4
OC 7000F 35	-	1820 €72	80/125	100-21(20)	-	80/125-5
OC 7000F 49	-	-	110/160	110-27(26)	-	110/160-14
OC 8000iF 19 - 19/120	-	1820 €72	80/125	80-20(19)	-	80/125-14
OC 8000iF 27 - 25/120	-	1820 €72	80/125	80-30(30)	-	80/125-30



<b>BRÖTJE</b>	<b>Anschlussstück Kesselhersteller</b>	<b>ATEC Anschlussadapter gerade</b>	<b>Verbindungsleitung</b>	<b>Steigleitung einwandig</b>	<b>Außenwandmontage</b>
<b>raumluftabhängig</b>					
BBS EVO 15 i SSP/RSP	-	0130 €32	60	60-22(20)	80-30(30)
BBS EVO 20 i SSP/RSP	-	-	80	60-15(14)	80-30(30)
BBS EVO 28 i SSP/RSP	-	-	80	80-30(30)	-
BBK EVO 20/22 i	-	-	80	80-30(30)	-
BGB EVO 15 i	-	0130 €32	60	60-22(20)	-
BGB EVO 20 i	-	-	80	80-30(30)	-
BGB EVO 28 i	-	-	80	80-30(30)	-
BGB EVO 38 i	-	-	80	80-30(30)	-
BGB 50 i	-	-	110	100-30(30)	-
BGB 70 i	-	-	110	110-30(30)	-
BGB 90 i	-	-	110	110-30(29)	-
BGB 110 i	-	-	110	110-23(21)	125-30(30)
BMK 20/24 B / BMR 20/24 B	-	1137 €35	60	80-30(30)	-
SGB 125 i	-	6115 €75	160	125-24(24)	160-30(30)
SGB 170 i	-	6115 €75	160	160-30(30)	-
SGB 215 i	-	8115 €77	200	160-30(30)	-
SGB 260 i	-	8115 €77	200	160-18(18)	200-30
SGB 300 i	-	8115 €77	200	200-30	-
SGB 400 i	-	8102 €155+8115 €77	200	200-30	-
SGB 470 i	-	8102 €155+8115 €77	200	200-23	-

**Fortsetzung Brötje raumluftabhängig**

SGB 540 i	-	8102 €155+8115 €77	-	200	200-11	250-30	-	200/265-11	250/315-30
SGB 610 i	-	9115 €110	-	250	250-30	-	-	250/315-30	-
WGB EVO 15 i	-	0130 €32	-	60	60-19(17)	80-30(30)	-	60/100-19	80/125-30
WGB EVO 20 i	-	-	-	80	80-30(30)	-	-	80/125-30	-
WGB EVO 28 i	-	-	-	80	80-30(28)	-	-	80/125-30	-
WGB EVO 38 i	-	-	-	80	80-30(30)	-	-	80/125-30	-
WGB-M EVO 20 i	-	-	-	80	80-30(30)	-	-	80/125-30	-
WGB-K EVO 20/28 i	-	-	-	80	80-30(30)	-	-	80/125-30	-
WGB-U 15 i	-	0130 €32	-	60	60-23(20)	80-30(30)	-	60/100-23	80/125-30
WGB-U 20 i / WGB-C 20/24 i	-	-	-	80	80-30(30)	-	-	80/125-30	-
WGB 50 i	-	-	-	110	110-30(30)	-	-	110/160-30	-
WGB 70 i	-	-	-	110	110-30(30)	-	-	110/160-30	-
WGB 90 i	-	-	-	110	110-30(29)	-	-	110/160-30	-
WGB 110 i	-	-	-	110	110-23(21)	125-30(30)	-	110/160-23	125/190-30
WMS 12 C	-	-	-	60	60-30(30)	-	-	60/100-30	-
WMS 24 C	-	1137 €35	-	80	80-30(30)	-	-	80/125-30	-
WMC 20/33 C	-	1137 €35	-	80	80-30(28)	-	-	80/125-30	-
WLS 24	-	1137 €35	-	80	80-30(30)	-	-	80/125-30	-
WLC 24/28	-	1137 €35	-	80	80-30(30)	-	-	80/125-30	-
BOB 20 B	-	-	-	80	80-30(30)	-	-	80/125-30	-
BOB 32/40 B	-	2232 €51	-	100	100-30(30)	-	-	100/150-30	-
BOB 25 B	-	-	-	80	80-30(30)	-	-	80/125-30	-
BOK 19	-	1115 €33	-	80	80-28(25)	-	-	80/125-28	-
BOK 24	-	1115 €33	-	80	80-25(23)	-	-	80/125-25	-
BOK 32	-	1115 €33	-	80	80-20(18)	100-30(30)	-	80/125-20	100/150-30
BOK 40	-	3115 €56	-	110	110-30(30)	-	-	110/160-30	-
LC 54 LogoCondens	-	4104 €118+4115 €60	-	125	125-30(30)	-	-	125/190-30	-
LC 76 LogoCondens	-	4104 €118+4115 €60	-	125	125-14(13)	-	-	125/190-14	-
LC 98 LogoCondens	-	6115 €75	-	160	160-30(30)	-	-	125/190-13	160/230-30
LC 131 LogoCondens	-	6115 €75	-	160	160-30(30)	-	-	160/230-30	-
LC 164 LogoCondens	-	6115 €75	-	160	160-30(30)	-	-	160/230-30	-
LC 196 Logo Condens	-	6115 €75	-	160	160-28(27)	-	-	160/230-28	-



<b>BRÖTJE</b>	<b>Anschlussstück Kesselhersteller</b>	<b>ATEC Anschlussadapter gerade</b>		<b>Verbindungs- leitung</b>	<b>Steigleitung einwandig</b>		<b>konzentrisch</b>	<b>Außenwandmontage</b>	
<b>raumluftunabhängig</b>									
BBS EVO 15 i SSP/RSP	-	0866 €61	-	60/100	60-19(17)	80-30(30)	60/100-13	60/100-22	80/125-30
BBS EVO 20 i SSP/RSP	-	-	-	80/125	80-30(30)	-	80/125-30	80/125-30	-
BBS EVO 28 i SSP/RSP	-	-	-	80/125	80-29(26)	-	80/125-20	80/125-30	-
BBK EVO 20/22 i	-	-	-	80/125	80-30(30)	-	80/125-30	80/125-30	-
BGB EVO 15 i	-	0866 €61	-	60/100	60-18(17)	-	60/100-13	60/100-22	-
BGB EVO 20 i	-	-	-	80/125	80-30(30)	-	80/125-30	80/125-30	-
BGB EVO 28 i	-	-	-	80/125	80-30(30)	-	80/125-22	80/125-30	-
BGB EVO 38 i	-	-	-	80/125	80-21(19)	100-30(30)	80/125-14	80/125-30	-
BGB 50 i	-	-	-	110/160	100-24(22)	110-30(30)	100/150-19	100/150-30	-
BGB 70 i	-	-	-	110/160	110-19(18)	125-30(26)	110/160-9	110/160-30	-
BGB 90 i	-	-	-	110/160	110-13(12)	125-23(22)	110/160-6	110/160-28	-
BGB 110 i	-	-	-	110/160	125-15(15)	160-30(30)	125/190-15	110/160-19	125/190-30
BMK 20/24 B / BMR 20/24 B	-	1866 €61	-	60/100	80-30(28)	-	80/125-20	80/125-30	-
SGB 125 i	-	6115 €75	-	160	auf Anfrage	-	-	auf Anfrage	-
SGB 170 i	-	6115 €75	-	160	auf Anfrage	-	-	auf Anfrage	-
SGB 215 i	-	8115 €77	-	200	auf Anfrage	-	-	auf Anfrage	-
SGB 260 i	-	8115 €77	-	200	auf Anfrage	-	-	auf Anfrage	-
SGB 300 i	-	8115 €77	-	200	auf Anfrage	-	-	auf Anfrage	-
SGB 400 i	-	8102 €155+8115 €77	-	200	auf Anfrage	-	-	auf Anfrage	-
SGB 470 i	-	8102 €155+8115 €77	-	200	auf Anfrage	-	-	auf Anfrage	-
SGB 540 i	-	8102 €155+8115 €77	-	200	auf Anfrage	-	-	auf Anfrage	-
SGB 610 i	-	9115 €110	-	250	auf Anfrage	-	-	auf Anfrage	-
WGB EVO 15 i	-	0866 €61	-	60/100	60-16(15)	80-30(30)	60/100-12	60/100-18	80/125-30
WGB EVO 20 i	-	-	-	80/125	80-30(30)	-	80/125-30	80/125-30	-
WGB EVO 28 i	-	-	-	80/125	80-30(29)	-	80/125-22	80/125-30	-
WGB EVO 38 i	-	-	-	80/125	80-21(19)	-	80/125-14	80/125-30	-
WGB-M EVO 20 i	-	-	-	80/125	80-30(30)	-	80/125-30	80/125-30	-
WGB-K EVO 20/28 i	-	-	-	80/125	80-30(30)	-	80/125-28	80/125-30	-
WGB-U 15 i	-	0866 €61	-	60/100	60-20(18)	80-30(30)	60/100-15	60/100-23	80/125-30
WGB-U 20 i / WGB-C 20/24 i	-	-	-	80/125	80-30(30)	-	80/125-30	80/125-30	-
WGB 50 i	-	-	-	110/160	110-30(30)	-	110/160-23	110/160-26	-
WGB 70 i	-	-	-	110/160	110-19(18)	125-30(30)	110/160-9	110/160-30	-
WGB 90 i	-	-	-	110/160	110-13(12)	125-23(22)	110/160-6	110/160-28	-
WGB 110 i	-	-	-	110/160	125-15(15)	160-30(30)	125/190-15	110/160-19	125/190-30
WMS 12 C	-	-	-	60/100	60-30(30)	-	60/100-28	60/100-30	-
WMS 24 C	-	1866 €61	-	80/125	80-30(30)	-	80/125-30	80/125-30	-
WMC 20/33 C	-	1866 €61	-	80/125	80-20(18)	-	80/125-14	80/125-30	-
WLS 24	-	1866 €61	-	80/125	80-30(30)	-	80/125-30	80/125-30	-
WLC 24/28	-	1866 €61	-	80/125	80-30(29)	-	80/125-22	80/125-30	-
BOB 20 B	-	-	-	80/125	80-30(30)	-	80/125-26	80/125-30	-
BOB 32/40 B	-	-	-	110/160	110-30(30)	-	110/160-30	110/160-30	-
BOB 25 B	-	-	-	80/125	80-28(25)	-	80/125-19	80/125-30	-



<b>BRUNS</b>	<b>Anschlussstück Kesselhersteller</b>	<b>ATEC Anschlussadapter gerade</b>		<b>Verbindungs- leitung</b>	<b>Steigleitung einwandig</b>		<b>Außenwandmontage</b>		
<b>raumluftabhängig</b>									
TREND-BW 8-14	-	1115 €33	-	80	80-20(20)	-	-	80/125-20	-
TREND-BW 15-23	-	1115 €33	-	80	80-25(25)	-	-	80/125-24	-
TREND-BW 20-30	-	1115 €33	-	80	80-30(24)	-	-	80/125-30	-
Trend BWA I, BWA II und BWA WZ II	-	1115 €33	-	80	80-30(30)	-	-	80/125-30	-



<b>BRUNS</b>	<b>Anschlussstück Kesselhersteller</b>	<b>ATEC Anschlussadapter gerade</b>	<b>Verbindungs- leitung</b>	<b>Steigleitung einwandig</b>	<b>konzentrisch</b>	<b>Außenwandmontage</b>
<b>raumluftunabhängig</b>						
TREND-BW 8-14	-	440030 €156	80/125	80-20(20)	-	80/125-20 80/125-20 -
TREND-BW 15-23	-	440030 €156	80/125	80-20(20)	-	80/125-20 80/125-20 -
TREND-BW 20-30	-	440030 €156	80/125	80-20(18)	-	80/125-18 80/125-20 -
Trend BWA I, BWA II und BWA WZ II	-	440030 €156	80/125	80-30(30)	-	80/125-30 80/125-30 -



<b>BUDERUS</b>	<b>Anschlussstück Kesselhersteller</b>	<b>ATEC Anschlussadapter gerade</b>	<b>Verbindungs- leitung</b>	<b>Steigleitung einwandig</b>	<b>Außenwandmontage</b>
<b>raumluftabhängig</b>					
GB 102S-16 Logano Plus	-	-	80	60-23(21) 80-30(30)	- 60/100-23 80/125-30
GB 102S-30 Logano Plus	-	-	80	80-30(30)	- 80/125-30 -
GB 162-50 V2 Logamax Plus	-	-	110	100-30(30)	- 110/150-30 -
GB 162-70 V2 Logamax Plus	-	-	110	110-30(30)	- 110/160-30 -
GB 162-85 V2 Logamax Plus	-	-	110	110-30(30)	- 110/160-30 -
GB 162-100 V2 Logamax Plus	-	-	110	110-30(30)	- 110/160-30 -
GB 172-14 / GB 172i-17 T100S Logamax Plus-	-	-	80	80-30(30)	- 80/125-30 -
GB 172-20 / GB 172i-24 T100S Logamax Plus	-	-	80	80-30(30)	- 80/125-30 -
GB 172-24 Logamax Plus	-	-	80	80-20(20)	- 80/125-20 -
GB 172i.2-15 W / 172i.2-20 W H / 172i.2-20 KDW / 172i.2-25 W H	-	-	80	80-30(30)	- 80/125-30 -
GB 182i-14 Logamax Plus	-	0130 €32	60	60-23(15)	- 60/100-20 -
GB 182i-20 Logamax Plus	-	-	80	80-30(30)	- 80/125-30 -
GB 182i-20KD (WW) Logamax Plus	-	-	80	80-30(21)	- 80/125-30 -
GB 182i-24 kW Logamax Plus	-	-	80	80-30(30)	- 80/125-30 -
GB 182i-35K Logamax Plus	-	-	80	80-27(18)	- 80/125-25 -
GB 182i-42 Logamax Plus	-	-	80	80-28(18)	- 80/125-28 -
GB 182i.2-15 W H / 182i.2-20 W H / 182i.2-25 W H	-	-	80	80-30(30)	- 80/125-30 -
GB 182i.2-35 W H Logamax Plus	-	-	80	80-30(30)	- 80/125-30 -
GB 182i.2-45 W H Logamax Plus	-	-	80	80-30(27)	- 80/125-30 -
GB 192i-15 / GB 192i-25 Logamax Plus	-	-	80	80-20(20)	- 80/125-20 -
GB 192i-19 Logamax Plus	-	-	80	80-30(30)	- 80/125-30 -
GB 192i-35 Logamax Plus	-	-	80	80-28(18)	100-30(30) - 80/125-27 -
GB 192i-50 Logamax Plus	-	-	80	80-19(13)	100-30(30) - 80/125-18 -
GB 192i.2-15 / 192i.2-25 Logamax Plus	-	-	80	80-30(30)	- 80/125-30 -
GB 192i.2-35 Logamax Plus	-	-	80	80-30(30)	- 80/125-30 -
GB 192i.2-50 Logamax Plus	-	-	80	80-30(27)	- 80/125-30 -
GB 212-15/5 / 22/6 Logano Plus	-	-	80	80-25(25)	- 80/125-25 -
GB 212-30/9 Logano Plus	-	-	80	80-25(25)	- 80/125-25 -
GB 212-40/10 Logano Plus	-	-	80	80-25(18)	- 80/125-25 -
GB 212-50 Logano Plus	-	-	80	80-20(15)	- 80/125-20 -
GB 272-50 H Logamax Plus	-	-	110	110-30(30)	- 110/160-30 -
GB 272-70 H Logamax Plus	-	-	110	110-30(30)	- 110/160-30 -
GB 272-85 H Logamax Plus	-	-	110	110-30(30)	- 110/160-30 -
GB 272-100 H Logamax Plus	-	-	110	110-30(30)	- 110/160-30 -
GB 272-125 H Logamax Plus	-	-	110	110-27(25)	- 110/160-27 -
GB 272-150 H Logamax Plus	-	-	110	110-24(22)	- 110/160-24 -
GB 402-320 Logano Plus	-	8102 €155	200	200-30	- 200/265-30 -
GB 402-395 Logano Plus	-	-	250	200-30	- 200/265-30 -
GB 402-470 / 545 Logano Plus	-	-	250	250-30	- 250/315-30 -
GB 402-620 Logano Plus	-	-	250	250-30	- 250/315-30 -
KB 192i-15 / 192iT-15 Logano Plus	-	-	80	80-30(30)	- 80/125-30 -
KB 192i-30 Logano Plus	-	-	80	80-30(26)	- 80/125-30 -
KB 192i-50 Logano Plus	-	-	80	80-20(14)	100-30(30) - 80/125-20 100/150-30
KB 195iT-19 Logano Plus	-	-	80	80-30(30)	- 80/125-30 -
KB 195iT-25 Logano Plus	-	-	80	80-30(30)	- 80/125-30 -
KB 372-75 Logano Plus	-	-	110	110-30(30)	- 110/160-30 -
KB 372-100 Logano Plus	-	-	110	110-26(19)	- 110/160-24 -
KB 372-150 Logano Plus	-	4104 €118	125	125-23(15)	- 125/190-23 -
KB 372-200 / 250 / 300 Logano Plus	-	-	200	200-30	- 200/265-30 -
GB 125-18 Logano Plus	7747016312	-	80	80-20(18)	- 80/125-20 -
GB 125-22 Logano Plus	7747016312	-	80	80-20(14)	- 80/125-20 -
GB 125-30 Logano Plus	7747016312	-	80	80-12(8)	100-20(20) - 80/125-11 -
GB 125-35 Logano Plus	7747016312	-	80	80-14(10)	100-25(25) - 80/125-13 -
GB 125-49 Logano Plus	7747016312	-	80	80-6(4)	100-28(19) - 80/125-7 100/150-30
GB 125-60 Logano Plus	7747016312	-	80	100-9(7)	110-21(16) 100/150-9 110/160-21
GB 225-45 / 55 Logano Plus	-	4115 €60	125	125-20(20)	- 125/190-25 -
GB 225-68 Logano Plus	-	6104 €122+6115 €75-	160	160-30(30)	- 160/230-30 -
SB 105-19 Logano Plus	-	-	80	80-23(16)	- 80/125-20 -
SB 105-27 Logano Plus	-	-	80	80-13(9)	- 80/125-16 -
SB 325-50 / SB 325-70 Logano Plus	87090602	4115 €60	125	125-30(30)	- 125/190-30 -
SB 325-90 Logano Plus	87090602	6115 €75	160	125-30(20)	- 125/190-30 -
SB 325-115 Logano Plus	87090602	6102 €150+6115 €75-	160	160-30(30)	- 160/230-30 -



<b>BUDERUS</b>	<b>Anschlussstück Kesselhersteller</b>	<b>ATEC Anschlussadapter gerade</b>	<b>Verbindungs- leitung</b>	<b>Steigleitung einwandig</b>	<b>konzentrisch</b>	<b>Außenwandmontage</b>
<b>raumluftunabhängig</b>						
GB 102S-16 Logano Plus	-	-	80/125	60-20(18)	80-30(30)	60/100-14 60/100-24 80/125-30
GB 102S-30 Logano Plus	-	-	80/125	80-18(17)	-	80/125-12 80/125-30 -
GB 162-50 V2 Logamax Plus	-	-	110/160	100-24(22)	-	100/150-18 100/150-30 -
GB 162-70 V2 Logamax Plus	-	-	110/160	110-30(30)	-	110/160-19 110/160-30 -
GB 162-85 V2 Logamax Plus	-	-	110/160	110-30(30)	-	110/160-17 110/160-30 -
GB 162-100 V2 Logamax Plus	-	-	110/160	110-24(23)	-	110/160-13 110/160-30 -
GB 172-14 / GB 172i-17 T100S Logamax Plus	-	-	80/125	80-30(30)	-	80/125-30 80/125-30 -
GB 172-20 / GB 172i-24 T100S Logamax Plus	-	-	80/125	80-30(30)	-	80/125-30 80/125-30 -
GB 172-24 Logamax Plus	-	-	80/125	80-17(13)	-	80/125-13 80/125-20 -
GB 172i.2-15 W / 172i.2-20 W H / 172i.2-20 KDW / 172i.2-25 W H	-	-	80/125	80-30(30)	-	80/125-30 80/125-30 -

**Fortsetzung Buderus raumluftunabhängig**

GB 182i-14 Logamax Plus	-	0866 €61	-	60/100	60-15(10)	-	60/100-13	60/100-16	-
GB 182i-20 Logamax Plus	-	-	-	80/125	80-30(29)	-	80/125-29	80/125-30	-
GB 182i-20KD (WW) Logamax Plus	-	-	-	80/125	80-17(13)	-	80/125-15	80/125-20	-
GB 182i-24 kW Logamax Plus	-	-	-	80/125	80-17(14)	-	80/125-21	80/125-30	-
GB 182i-35K Logamax Plus	-	-	-	80/125	80-15(11)	100-30(30)	100/150-30	80/125-25	-
GB 182i-42 Logamax Plus	-	-	-	80/125	80-16(11)	-	80/125-13	80/125-25	-
GB 182i.2-15 W H / 182i.2-20 W H / 182i.2-25 W H	-	-	-	80/125	80-30(30)	-	80/125-30	80/125-30	-
GB 182i.2-35 W H Logamax Plus	-	-	-	80/125	80-30(30)	-	80/125-30	80/125-30	-
GB 182i.2-45 W H Logamax Plus	-	-	-	80/125	80-28(25)	-	80/125-26	80/125-30	-
GB 192i-15 / GB 192i-25 Logamax Plus	-	-	-	80/125	80-20(20)	-	80/125-15	80/125-20	-
GB 192i-19 Logamax Plus	-	-	-	80/125	80-30(30)	-	80/125-30	80/125-30	-
GB 192i-35 Logamax Plus	-	-	-	80/125	80-18(14)	100-24(21)	80/125-14	80/125-23	-
GB 192i-50 Logamax Plus	-	-	-	80/125	80-12(9)	100-30(27)	80/125-9	80/125-14	100/150-30
GB 192i.2-15 / 192i.2-25 Logamax Plus	-	-	-	80/125	80-30(30)	-	80/125-30	80/125-30	-
GB 192i.2-35 Logamax Plus	-	-	-	80/125	80-30(27)	-	80/125-20	80/125-30	-
GB 192i.2-50 Logamax Plus	-	-	-	80/125	80-23(19)	-	80/125-14	80/125-29	-
GB 212-15/5 / 22/6 Logano Plus	-	-	-	80/125	80-25(22)	-	80/125-22	80/125-25	-
GB 212-30/9 Logano Plus	-	-	-	80/125	80-20(15)	-	80/125-17	80/125-25	-
GB 212-40/10 Logano Plus	-	-	-	80/125	80-15(11)	100-25(25)	80/125-13	80/125-25	-
GB 212-50 Logano Plus	-	-	-	80/125	100-25(25)	-	-	80/125-14	-
GB 272-50 H Logamax Plus	-	-	-	110/160	110-30(30)	-	110/160-27	110/160-30	-
GB 272-70 H Logamax Plus	-	-	-	110/160	110-30(30)	-	110/160-23	110/160-30	-
GB 272-85 H Logamax Plus	-	-	-	110/160	110-28(27)	-	110/160-14	110/160-30	-
GB 272-100 H Logamax Plus	-	-	-	110/160	110-26(25)	-	110/160-30	-	-
GB 272-125 H Logamax Plus	-	-	-	110/160	110-11(10)	125-21(20)	-	110/160-17	125/190-30
GB 272-150 H Logamax Plus	-	-	-	110/160	110-9(8)	125-18(17)	-	110/160-14	125/190-30
GB 402-320 Logano Plus	-	8102 €155	-	200/265	200-30	-	-	200/265-30	-
GB 402-395 Logano Plus	-	-	-	250	200-25	250-30	-	200/265-20	250/315-30
GB 402-470 / 545 Logano Plus	-	-	-	250	250-30	-	-	250/315-30	-
GB 402-620 Logano Plus	-	-	-	250	250-30	-	-	250/315-27	-
KB 192i-15 / 192iT-15 Logano Plus	-	-	-	80/125	80-30(30)	-	80/125-30	80/125-30	-
KB 192i-30 Logano Plus	-	-	-	80/125	80/25(18)	-	80/125-19	80/125-30	-
KB 192i-50 Logano Plus	-	-	-	80/125	80-14(10)	100-30(29)	80/125-10	80/125-16	100/150-30
KB 195iT-19 Logano Plus	-	-	-	80/125	80-30(30)	-	80/125-30	80/125-30	-
KB 195iT-25 Logano Plus	-	-	-	80/125	80-30(30)	-	80/125-18	80/125-30	-
KB 372-75 Logano Plus	-	-	-	110/160	110-26(20)	-	110/160-17	110/160-30	-
KB 372-100 Logano Plus	-	-	-	110/160	110-11(8)	125-30(30)	110/160-7	110/160-20	-
KB 372-150 Logano Plus	-	-	-	160/230	125/190-23	-	-	160/230-30	-
GB 125-18 Logano Plus	7747016312	-	-	80/125	80-16(13)	-	80/125-14	80/125-20	-
GB 125-22 Logano Plus	7747016312	-	-	80/125	80-12(9)	-	80/125-10	80/125-18	-
GB 125-30 Logano Plus	7747016312	1166 €55	-	80/125	100-14(12)	80-14(10)	100/150-12	80/125-14	100/150-20
GB 125-35 Logano Plus	7747016312	2266 €97	-	100/150	100-18(16)	80-14(10)	100/150-17	100/150-20	-
GB 125-49 Logano Plus	7747016312	-	-	80/125	80-6(4)	100-29(21)	-	80/125-7	100/150-30
SB 105-19 Logano Plus	-	-	-	80/125	80-10(9)	-	80/125-10	80/125-18	-
SB 105-27 Logano Plus	-	-	-	80/125	80-15(10)	100-30(25)	80/125-15	80/125-17	-



DAIKIN / ROTEX	Anschlussstück Kesselhersteller	ATEC Anschlussadapter gerade	Verbindungs- leitung	Steigleitung einwandig	Außenwandmontage
<b>raumluftabhängig</b>					
C Gas ECH2 O 315/515	-	0115 €35	60	60-30(30)	60/100-30
C Gas ECH2 O 320/520	-	0115 €35	60	60-30(23)	60/100-30
C Gas ECH2 O 524	-	1137 €35+1115 €33	80	80-30(30)	80/125-30
C Gas ECH2 O 528	-	1137 €35+1115 €33-	80	80-30(30)	80/125-30
C Gas W Top / 3C Gas W 12T	-	-	60	60-20(20)	60/100-20
C Gas W Top / 3C Gas W 18T	-	1137 €35	80	80-30(30)	80/125-30
C Gas W Top / 3C Gas W 22C/T	-	1137 €35	80	80-20(20)	80/125-20
C Gas W Top / 3C Gas W 28C/T	-	1137 €35	80	80-20(20)	80/125-20
C Gas W Top / 3C Gas W 33C/T	-	1137 €35	80	80-20(18)	80/125-20
HPU Hybrid-Gasbrennwert-Modul	-	1157 €40	80	80-20(14)	80/125-20
C Oil A2F 18H	-	1115 €33	80	80-30(30)	80/125-30
C Oil A2F 24H	-	1115 €33	80	80-30(30)	80/125-30
C Oil A2F 32H	-	1115 €33	80	80-30(30)	80/125-30



DAIKIN / ROTEX	Anschlussstück Kesselhersteller	ATEC Anschlussadapter gerade	Verbindungs- leitung	Steigleitung einwandig	konzentrisch	Außenwandmontage
<b>raumluftunabhängig</b>						
C Gas ECH2 O 315/515	-	0820 €72	60/100	60-30(30)	60/100-30	60/100-30
C Gas ECH2 O 320/520	-	1866 €61+1820 €72	80/125	80-30(30)	80/125-30	80/125-30
C Gas ECH2 O 524	-	1266 €62+1220 €67-	80/125	80-30(30)	80/125-30	80/125-30
C Gas ECH2 O 528	-	1266 €62+1220 €67-	80/125	80-30(30)	80/125-30	80/125-30
C Gas W Top / 3C Gas W12T	-	-	60/100	60-20(20)	60/100-20	60/100-20
C Gas W Top / 3C Gas W18T	-	1266 €62	80/125	80-30(30)	80/125-30	80/125-30
C Gas W Top / 3C Gas W 22C/T	-	1866 €61	80/125	80-16(12)	80/125-14	80/125-20
C Gas W Top / 3C Gas W 28C/T	-	1266 €62	80/125	80-14(11)	80/125-11	80/125-18
C Gas W Top / 3C Gas W 33C/T	-	1266 €62	80/125	80-11(8)	100-25(20)	80/125-20
HPU Hybrid-Gasbrennwert-Modul	-	1866 €61	80/125	80-11(8)	100-28(24)	80/125-10
C Oil A2F 18H	-	1220 €67	80/125	80-30(30)	80-30(30)	80/125-30
C Oil A2F 24H	-	1220 €67	80/125	80-30(30)	80-30(30)	80/125-30
C Oil A2F 32H	-	1220 €67	80/125	80-30(28)	80-20(29)	80/125-30



ELCO	Anschlussstück Kesselhersteller	ATEC Anschlussadapter gerade	Verbindungs- leitung	Steigleitung einwandig	Außenwandmontage
<b>raumluftabhängig</b>					
THISION MINI 15.3	-	-	60	60-30(30)	60/100-30
THISION MINI 22.3 / Combi 22.3	-	-	60	60-13(11)	80/125-30
THISION MINI 28.3	-	1137 €35	80	80-30(30)	80/125-30
THISION S PLUS 13,19 / 13,19 Compact V / 13,19 Solar V	-	-	80	80-30(30)	80/125-30
THISION S PLUS 24 / 24 Compact V / 24 Solar V	-	-	80	80-30(30)	80/125-30

**Fortsetzung Elco raumluftabhängig**

THISION S PLUS 24 Combi	-	-	80	80-29(25)	-	-	80/125-29	-
THISION S PLUS 34 / 34 Combi / 30 Compact V / 34 Solar V-	-	-	80	80-20(18)	100-30(30)	-	80/125-20	100/150-30
THISION S PLUS 46	-	-	80	80-12(11)	100-30(30)	-	80/125-12	100/150-30
THISION S PLUS 54	-	-	80	100-30(30)	-	-	100/150-30	-
TRIGON S PLUS 13,15,19	-	-	80	80-30(30)	-	-	80/125-30	-
TRIGON S PLUS 24	-	-	80	80-30(30)	-	-	80/125-30	-
TRIGON S PLUS 34	-	-	80	80-23(20)	-	-	80/125-23	-
TRIGON S PLUS 40	-	-	80	80-18(16)	100-30(30)	-	80/125-18	100/150-30
TRIGON L PLUS / THISION L PLUS 60	-	-	100	100-30(30)	-	-	100/150-30	-
TRIGON L PLUS / THISION L PLUS 70	-	-	100	100-30(30)	-	-	100/150-30	-
TRIGON L PLUS / THISION L PLUS 100	-	-	100	100-19(16)	-	-	100/150-19	-
TRIGON L PLUS / THISION L PLUS 120	-	-	100	100-6(5)	125-30(30)	-	100/150-6	125/190-30
TRIGON L PLUS / THISION L PLUS 140	-	3151 €59	100	125-28(26)	-	-	125/190-28	-
TRIGON L PLUS / THISION L PLUS 170	-	4106 €124	125	125-14(13)	160-30(30)	-	125/190-14	160/230-30
TRIGON L PLUS / THISION L PLUS 200	-	4106 €124	125	125-13(13)	160-30(30)	-	125/190-13	160/230-30
TRIGON XL 150	-	4101 €118+4115 €60-	125	125-30(30)	-	-	125/190-30	-
TRIGON XL 200	-	4101 €118+4115 €60-	125	125-24(24)	160-30(30)	-	125/190-24	160/230-30
TRIGON XL 250	-	6118 €155+6115 €75-	160	160-30(30)	-	-	160/230-30	-
TRIGON XL 300	-	6118 €155+6115 €75-	160	160-30(30)	-	-	160/230-30	-
TRIGON XL 400	-	6118 €155+6115 €75-	160	160-30(30)	-	-	160/230-30	-
TRIGON XL 500	-	9101 €187+8115 €77-	200	200-30	-	-	200/265-30	-
TRIGON XL 570	-	9101 €187+8115 €77-	200	200-30	-	-	200/265-30	-
STRATON S 17.2	-	1115 €33	80	80-30(30)	-	-	80/125-30	-
STRATON S 21.2	-	1115 €33	80	80-30(30)	-	-	80/125-30	-
STRATON S 26.2	-	1115 €33	80	80-30(30)	-	-	80/125-30	-
STRATON S 30.2	-	1115 €33	80	80-30(30)	-	-	80/125-30	-
STRATON S 35.2	-	1115 €33	80	80-26(23)	100-30(30)	-	80/125-26	100/150-30
STRATON S 40.2	-	1115 €33	80	80-18(16)	100-30(30)	-	80/125-18	100/150-30



ELCO	Anschlussstück Kesselhersteller	ATEC Anschlussadapter gerade	Verbindungsleitung	Steigleitung einwandig	konzentrisch	Außenwandmontage
<b>raumluftunabhängig</b>						
THISION MINI 15.3	3722818	-	60/100	60-29(26)	-	60/100-21 60/100-30 -
THISION MINI 22.3 / Combi 22.3	3722818	-	60/100	60-10(9)	80-30(30)	60/100-7 60/100-12 80/125-30
THISION MINI 28.3	3722818	1222 €62	80/125	80-30(30)	-	80/125-27 80/125-30 -
THISION S PLUS 13,15,19 / 13,19 Compact V / 13,19 Solar V	-	-	80/125	80-30(30)	-	80/125-30 80/125-30 -
THISION S PLUS 24 / 24 Compact V / 24 Solar V	-	-	80/125	80-30(30)	-	80/125-30 80/125-30 -
THISION S PLUS 24 Combi	-	-	80/125	80-17(16)	-	80/125-11 80/125-28 -
THISION S PLUS 34 / 34 Combi / 30 Compact V / 34 Solar V	-	-	80/125	80-13(12)	100-30(30)	80/125-9 80/125-19 100/150-30
THISION S PLUS 46	-	-	80/125	100-23(21)	-	80/125-5 80/125-11 100/150-30
THISION S PLUS 54	-	-	80/125	100-13(12)	-	100/150-9 100/150-30 -
TRIGON S PLUS 13,15,19	-	-	80/125	80-30(30)	-	80/125-30 80/125-30 -
TRIGON S PLUS 24	-	-	80/125	80-30(30)	-	80/125-30 80/125-30 -
TRIGON S PLUS 34	-	-	80/125	80-14(12)	100-30(30)	80/125-9 80/125-22 -
TRIGON S PLUS 40	-	-	80/125	100-30(30)	-	80/125-7 80/125-17 100/150-30
TRIGON L PLUS / THISION L PLUS 60	-	-	100/150	100-30(27)	-	100/150-19 100/150-30
TRIGON L PLUS / THISION L PLUS 70	-	-	100/150	100-20(19)	-	100/150-11 100/150-30
TRIGON L PLUS / THISION L PLUS 100	-	-	100/150	100-8(8)	-	100/150-5 100/150-17
TRIGON L PLUS / THISION L PLUS 120	-	-	100/150	125-8(8)	-	125/190-6 100/150-4 125/190-24
TRIGON L PLUS / THISION L PLUS 140 - 200	auf Anfrage	-	-	-	-	-
STRATON S 17.2	21775	-	80/125	80-30(30)	-	80/125-30 80/125-30 -
STRATON S 21.2	21775	-	80/125	80-30(30)	-	80/125-30 80/125-30 -
STRATON S 26.2	21775	-	80/125	80-30(30)	-	80/125-24 80/125-30 -
STRATON S 30.2	21775	-	80/125	80-24(22)	-	80/125-17 80/125-30 -
STRATON S 35.2	21775	-	80/125	80-16(15)	100-30(30)	80/125-11 80/125-25 100/150-30
STRATON S 40.2	21775	-	80/125	100-30(30)	-	100/150-25 100/150-30 -



GIERSCH CTC	Anschlussstück Kesselhersteller	ATEC Anschlussadapter gerade	Verbindungsleitung	Steigleitung einwandig	Außenwandmontage
<b>raumluftabhängig</b>					
GiegaSwift Plus 24, 24d, 28c	-	1137 €35	80	80-20(20)	- 80/125-20 -
GiegaStar 15	-	0130 €32	60	60-18(12)	- 60/100-15 -
GiegaStar Plus 25 / C28	-	-	80	80-20(20)	- 80/125-20 -
GiegaStar Plus 35	-	-	80	80-25(20)	- 80/125-20 -
GiegaStar Plus 46	-	-	80	80-22(15)	- 80/125-20 -
GiegaStar Plus 66	-	-	100	100-25(17)	- 100/150-20 -
GiegaStar Plus 86	-	-	100	100-20(14)	- 100/150-20 -
GiegaStar 116	-	-	100	100-16(10)	110-30(19) - 100/150-16 -
GiegaBloc 200-3	-	4101 €118	125	125-30(30)	- 125/190-30 -
GiegaBloc 200-4	-	4101 €118	125	125-25(17)	- 125/190-17 -
GiegaBloc 200-5	-	6101 €133	160	160-30(30)	- 160/230-30 -
GiegaBloc 200-6	-	6101 €133	160	160-30(30)	- 160/230-30 -
FCU17	-	1115 €33	80	80-30(23)	- 80/125-30 -
FCU25	-	1115 €33	80	80-17(12)	- 80/125-17 -
FCU30	-	1115 €33	80	80-13(10)	- 80/125-13 -
GK 50	-	3115 €56+1142 €43-	80	80-25(25)	- 80/125-20 -
GK 70	-	3115 €56+2232 €51-	100	100-30(30)	- 100/150-25 -
GK 100	-	3115 €56	110	110-23(16)	- 125/190-25 -
GK 250	-	4115 €60	160	160-30(28)	- 160/230-30 -



GIERSCH CTC	Anschlussstück Kesselhersteller	ATEC Anschlussadapter gerade	Verbindungsleitung	Steigleitung einwandig	konzentrisch	Außenwandmontage
<b>raumluftunabhängig</b>						
GiegaSwift Plus 24, 24d, 28c	-	1866 €61	80/125	80-18(14)	-	80/125-14 80/125-20 -
GiegaStar Plus 15	-	0866 €61	60/100	60-13(9)	-	60/100-10 60/100-15 -
GiegaStar Plus 25 / C28	-	-	80/125	80-20(18)	-	80/125-15 80/125-20 -
GiegaStar Plus 35	-	-	80/125	80-25(20)	-	80/125-15 80/125-20 -
GiegaStar Plus 46	-	-	80/125	80-13(10)	-	80/125-10 80/125-15 -

**Fortsetzung Giersch raumluftunabhängig**

GiegaStar Plus 66	-	-	-	100/150	100-9(7)	125-25(22)	100/150-6	100/150-15	-
GiegaStar Plus 86	-	-	-	100/150	125-25(20)	-	100/150-6	100/150-12	-
GiegaStar 116	-	-	-	100/150	110-11(8)	125-18(15)	110/160-8	110/160-15	-
FCU17	-	1220 €67	-	80/125	80-19(15)	-	80/125-15	80/125-30	-
FCU25	-	1220 €67	-	80/125	100-18(16)	-	80/125-8	80/125-14	-
FCU30	-	1220 €67	-	80/125	110-20(17)	-	-	100/150-20	-
GK 50	-	3820 €82+1868 €161	-	80/125	100-30(30)	-	80/125-13	80/125-18	-
GK 70	-	3820 €82	-	110/160	110-25(25)	-	110/160-25	110/160-30	-
GK 100	-	3820 €82	-	110/160	125-17	160-30(30)	125/190-15	125/190-30	-



HANSA	Anschlussstück Kesselhersteller	ATEC Anschlussadapter gerade	Verbindungs- leitung	Steigleitung einwandig		Außenwandmontage		
<b>raumluftunabhängig</b>								
PEGA 18 / PEGA 25_18	-	0130 €32	-	60	60-18(11)	-	60/100-18	-
PEGA 25	-	-	-	80	80-30/30	-	80/125-30	-
PEGA 40	-	-	-	80	80-30(25)	-	80/125-30	-
TANTUM 25 / TANTUM 25 Kombi / TANTUM 25 Kompakt 100	-	-	-	80	80-30(30)	-	80/125-30	-
Integra 36_19 / 36_25 / 36_31	-	-	-	80	100-26(24)	-	100/150-26	-
Integra 60_37 / 60_44 / 60_52	-	-	-	110	110-17(16)	-	110/160-17	-



HANSA	Anschlussstück Kesselhersteller	ATEC Anschlussadapter gerade	Verbindungs- leitung	Steigleitung einwandig	konzentrisch	Außenwandmontage			
<b>raumluftunabhängig</b>									
PEGA 18 / PEGA 25_18	-	0866 €61	-	60/100	60-14(10)	-	60/100-10	60/100-16	-
PEGA 25	-	-	-	80/125	80-30(30)	-	80/125-30	80/125-30	-
PEGA 40	-	-	-	80/125	80-23(17)	100-30(30)	80/125-18	80/125-30	-
TANTUM 25 / TANTUM 25 Kombi / TANTUM 25 Kompakt 100	-	-	-	80/125	80-28(22)	-	80/125-23	80/125-28	-



HOVAL	Anschlussstück Kesselhersteller	ATEC Anschlussadapter gerade	Verbindungs- leitung	Steigleitung einwandig		Außenwandmontage		
<b>raumluftunabhängig</b>								
TopGas comfort RS-OT / TTE 10 / 16 / 22	-	1115 €33	-	80	80-30(30)	-	80/125-30	-
TopGas combi RS-OT 21/18	-	1115 €33	-	80	80-30(30)	-	80/125-30	-
TopGas combi RS-OT 26/23	-	1115 €33	-	80	80-30(30)	-	80/125-30	-
TopGas combi RS-OT 32/28	-	1115 €33	-	80	80-30(30)	-	80/125-30	-
TopGas classic 35 / 45	-	2115 €44	-	100	100-30(30)	-	100/150-30	-
TopGas classic 60	-	2115 €44	-	100	100-30(30)	-	100/150-30	-
TopGas classic 80	-	2115 €44	-	100	100-30(30)	-	100/150-30	-
UltraGas 15 / UltraGas 20	-	1115 €33	-	80	80-30(30)	-	80/125-30	-
UltraGas 27	-	1115 €33	-	80	80-30(30)	-	80/125-30	-
UltraGas 35	-	1115 €33	-	80	80-30(30)	-	80/125-30	-
UltraGas 50	-	1115 €33	-	80	100-30(30)	-	100/150-30	-
UltraGas 70	-	2115 €44	-	100	100-30(30)	-	100/150-30	-
UltraGas 100	-	2115 €44	-	100	100-15(13)	125-30(30)	100/150-15	125/190-30
UltraGas 125	2029956	4104 €118+4115 €60	125	125	125-29(27)	-	125/190-29	-
UltraGas 150	2029956	6115 €75	160	160	160-30(30)	-	160/230-30	-
UltraGas 200 / PGS	6021252	6112 €155+6115 €75	160	160	160-30(30)	-	160/230-30	-
UltraGas 250 / PGS	6021252	8102 €155+8115 €77	160	160	160-30(30)	-	160/230-30	-
UltraGas 300 / PGS	6021252	8102 €155+8115 €77	200	200	200-30	-	200/265-30	-
UltraGas 350 / PGS	-	9107 €308+8102 €155	200	200	200-30	-	200/265-30	-
UltraGas 400 / PGS	-	9107 €308+8102 €155	200	200	200-30	-	200/265-30	-
UltraGas 450 / PGS	-	9107 €308+8102 €155	200	200	200-30	-	200/265-30	-
UltraGas 500 / PGS	-	9107 €308+8102 €155	200	200	200-19	250-30	200/265-19	250/315-30
UltraGas 575 / PGS	-	9107 €308+9115 €110	250	250	250-30	-	250/315-30	-
UltraGas 650 / PGS	-	9107 €308+9115 €110	250	250	250-30	-	250/315-30	-
UltraGas 720 / PGS	-	9107 €308+9115 €110	250	250	250-30	-	250/315-30	-
MultiJet 12 / MultiJet LSP	-	1115 €33	-	80	80-30(30)	-	80/125-30	-
MultiJet 16 / MultiJet LSP	-	1115 €33	-	80	80-30(30)	-	80/125-30	-
MultiJet 20 / MultiJet LSP	-	1115 €33	-	80	80-30(30)	-	80/125-30	-
MultiJet 25	-	1115 €33	-	80	80-30(30)	-	80/125-30	-
UltraOil 16 / 20	-	1115 €33	-	80	80-30(30)	-	80/125-30	-
UltraOil 25	-	1115 €33	-	80	80-30(30)	-	80/125-30	-
UltraOil 35	-	1115 €33	-	80	80-12(11)	100-30(30)	80/125-13	100/150-30
UltraOil 50	-	2115 €44	-	100	100-30(29)	-	100/150-30	-
UltraOil 65 / 80	2029956	6117 €154+6115 €75	160	160	125-30(30)	-	125/190-30	-
UltraOil 110 / 130	-	8115 €77	200	200	160-30(30)	-	160/230-30	-
UltraOil 160	-	8115 €77	160	160	160-30(30)	-	160/230-30	-
UltraOil 200	-	8115 €77	200	200	160-22(22)	200-30	160/230-22	200/265-30
UltraOil 250 / 300	-	9115 €110	250	250	200-30	-	200/265-30	-



HOVAL	Anschlussstück Kesselhersteller	ATEC Anschlussadapter gerade	Verbindungs- leitung	Steigleitung einwandig	konzentrisch	Außenwandmontage			
<b>raumluftunabhängig</b>									
TopGas comfort RS-OT / TTE 10 / 16 / 22	-	1220 €67	-	80/125	80-30(30)	-	80/125-30	80/125-30	-
TopGas combi RS-OT 21/18	-	1220 €67	-	80/125	80-30(30)	-	80/125-30	80/125-30	-
TopGas combi RS-OT 26/23	-	1220 €67	-	80/125	80-30(30)	-	80/125-27	80/125-30	-
TopGas combi RS-OT 32/28	-	1220 €67	-	80/125	80-27(25)	-	80/125-18	80/125-30	-
TopGas classic 35 / 45	-	-	-	100/150	100-30(30)	-	100/150-30	100/150-30	-
TopGas classic 60	-	2220 €100	3268 €84	100/150	100-24(22)	-	100/150-17	100/150-30	-
TopGas classic 80	-	2220 €100	3268 €84	100/150	100-10(10)	-	100/150-7	100/150-30	-
UltraGas 15 und 20	LAS-Bausatz 6027510	-	-	80/125	80-30(30)	-	80/125-30	80/125-30	-
UltraGas 27	LAS-Bausatz 6027510	-	-	80/125	80-30(30)	-	80/125-23	80/125-30	-
UltraGas 35	LAS-Bausatz 6027510	-	-	80/125	80-27(25)	100-30(30)	80/125-18	80/125-30	-
UltraGas 50	LAS-Bausatz 6027510	-	-	80/125	100-30(29)	-	100/150-23	100/150-30	-
UltraGas 70	-	2220 €100	3268 €84	100/150	100-13(12)	125-30(30)	100/150-9	100/150-30	-
UltraGas 100	-	2220 €100	3268 €84	100/150	125-14(14)	-	125/190-14	100/150-12	125/190-30
MultiJet 12 / MultiJet LSP	-	1218 €90	-	80/125	80-30(30)	-	80/125-30	80/125-30	-

**Fortsetzung Hoval raumluftunabhängig**

MultiJet 16 / MultiJet LSP	-	1218 €90	-	80/125	80-30(30)	-	80/125-30	80/125-30	-
MultiJet 20 / MultiJet LSP	-	1220 €67	-	80/125	80-30(30)	-	80/125-30	80/125-30	-
MultiJet 25	-	1820 €72/1220 €67	-	80/125	80-24(22)	-	80/125-17	80/125-30	-
UltraOil 16 / 20	LAS-Bausatz 6027510	-	-	80/125	80-30(30)	-	80/125-29	80/125-30	-
UltraOil 25	LAS-Bausatz 6027510	-	-	80/125	80-25(23)	-	80/125-17	80/125-30	-
UltraOil 35	LAS-Bausatz 6027510	-	-	80/125	80-7(6)	100-24(22)	80/125-4	80/125-12	100/150-30
UltraOil 50	-	-	-	100/150	100-13(12)	110-28(27)	100/150-10	100/150-30	-



INTERCAL	Anschlussstück Kesselhersteller	ATEC Anschlussadapter gerade	Verbindungsleitung	Steigleitung einwandig	Außenwandmontage
<b>raumluftunabhängig</b>					
ECOHEAT Streamline Gas 16 H/HE / 16/24 S/HE -	-	1115 €33	-	80	80/125-30 -
ECOHEAT Streamline Gas 25 H/HE / 25/32 S/HE -	-	1115 €33	-	80	80/125-30 -
ECOHEAT Plus Gas 20 N / F	-	1115 €33	-	80	- -
RATIOLINE Plus Gas 20 N / F	erforderlich	-	-	80	- -
ECOHEAT Plus Öl 15	-	1115 €33	-	80	- -
ECOHEAT Plus Öl 20	-	1115 €33	-	80	- -
ECOHEAT Plus Öl 25	-	1115 €33	-	80	- -
ECOHEAT Öl 30	-	1115 €33	-	100	- -
ECOHEAT Öl 40	-	1115 €33	-	100	- -
RATIOLINE Plus Öl 15	erforderlich	-	-	80	- -
RATIOLINE Plus Öl 20	erforderlich	-	-	80	- -



INTERCAL	Anschlussstück Kesselhersteller	ATEC Anschlussadapter gerade	Verbindungsleitung	Steigleitung einwandig	konzentrisch	Außenwandmontage
<b>raumluftunabhängig</b>						
ECOHEAT Streamline Gas 16 H/HE / 16/24 S/HE -	-	-	80/125	80-23(20)	-	80/125-30 80/125-30 -
ECOHEAT Streamline Gas 25 H/HE / 25/32 S/HE -	-	-	80/125	80-19(13)	-	80/125-21 80/125-30 -
ECOHEAT Plus Gas 20 N / F	erforderlich	-	80/125	80-14(11)	100-30	80/125-12 -
RATIOLINE Plus Gas 20 N / F	erforderlich	-	80/125	80-14(11)	100-25(25)	- -
ECOHEAT Plus Öl 15	erforderlich	-	80/125	80-25(20)	100-25(25)	- -
ECOHEAT Plus Öl 20	erforderlich	-	80/125	80-20(15)	100-25(25)	- -
ECOHEAT Plus Öl 25	erforderlich	-	80/125	80-14(11)	100-25(25)	- -
RATIOLINE Plus Öl 15	erforderlich	-	80/125	80-25(20)	100-30	80/125-21 -
RATIOLINE Plus Öl 20	erforderlich	-	80/125	80-20(15)	100-30	80/125-16 -



INTERDOMO	Anschlussstück Kesselhersteller	ATEC Anschlussadapter gerade	Verbindungsleitung	Steigleitung einwandig	Außenwandmontage
<b>raumluftunabhängig</b>					
Domostar GBK-15 / Plus 15-200 / floor 15	-	-	60	60-30(30)	60/100-30 -
Domostar GBK-25 / GBK-25C / GBK-25CSI / Plus 25-200 / floor 25	-	-	60	60-26(16)	80-30(30) 60/100-26 80/125-30
Domostar GBK-35 / floor 35 / GBK-25 x-floor-bicon OBK-17	-	1115 €33	60	60-13(8)	80-30(30) 60/100-13 80/125-30
bicon OBK-24	-	1115 €33	80	80-30(29)	- 80/125-30 -
			80	80-30(23)	- 80/125-30 -





INTERDOMO	Anschlussstück Kesselhersteller	ATEC Anschlussadapter gerade	Verbindungsleitung	Steigleitung einwandig	konzentrisch	Außenwandmontage
<b>raumluftunabhängig</b>						
Domostar GBK-15 / Plus 15-200 / floor 15	-	-	60/100	60-30(30)	-	60/100-30 60/100-30 -
Domostar GBK-25 / GBK-25C / GBK-25CSI / Plus 25-200 / floor 25	-	-	60/100	60-21(14)	80-30(30)	60/100-17 60/100-24 80/125-30
Domostar GBK-35 / floor 35 / GBK-25 x-floor-bicon OBK-17	-	1220 €67	60/100	60-11(7)	80-30(30)	60/100-9 60/100-11 80/125-30
bicon OBK-24	-	1220 €67	80/125	80-22(18)	-	80/125-18 80/125-30 -
			80/125	80-20(16)	-	80/125-15 80/125-30 -





MHG HEIZTECHNIK	Anschlussstück Kesselhersteller	ATEC Anschlussadapter gerade	Verbindungsleitung	Steigleitung einwandig	Außenwandmontage
<b>raumluftunabhängig</b>					
ecoGAS Pro 18	-	-	60	60-30(30)	60/100-30 -
ecoGAS Pro 24	-	-	60	60-30(28)	60/100-30 -
ecoGAS Pro 30	-	-	60	60-23(21)	80-30(30) 60/100-24 80/125-30
ecoGAS ProX 18/26	-	-	60	60-28(25)	- 60/100-28 80/125-30
ecoGAS ProX 30/38	-	-	60	60-17(13)	80-30(30) 60/100-16 80/125-30
ecoGAS 11	-	-	60	60-28(28)	- 60/100-30 -
ecoGAS 18	-	-	60	60-17(13)	80-30(30) 60/100-17 80/125-30
ecoGAS 24	-	-	80	80-30(30)	- 80/125-30 -
ecoGAS 30	-	-	80	80-28(28)	- 80/125-28 -
ecoGAS 45	-	-	80	80-18(14)	- 80/125-18 -
ecoGAS 18/24	-	-	60	60-17(13)	80-30(30) 60/100-17 80/125-30
ecoGAS 24/28	-	-	80	80-30(30)	- 80/125-30 -
ecoGAS 30/36	-	-	80	80-28(28)	- 80/125-28 -
ecoGAS 45/36	-	-	80	80-18(14)	100-30(30) 80/125-18 -
ecoGAS Kompakt	-	-	60	60-17(13)	80-30(30) 60/100-17 80/125-30
ProCon E 25	-	1115 €33	80	80-30(30)	- -
ProCon E 35	-	1115 €33	80	80-30(30)	- -
ecoDUO 15m - 27m	-	1115 €33	80	80-30(30)	- -
ecoDUO Gas 15-26 N / F	-	1115 €33	80	80-30(30)	- -
ecoOEL Pro 30	-	1115 €33	80	80-30(30)	- -
ecoOEL Pro 37 / 38m	-	1115 €33	80	80-12(8)	100-30(30) -
EcoStar 753 - 755	erforderlich	-	100	100-29(29)	- -
EcoStar 756	erforderlich	-	100	100-29(12)	- -
EcoStar plus 15 E /HS	-	1115 €33	80	80-30(30)	- 80/125-30 -
EcoStar plus 18 M /HS	-	1115 €33	80	80-30(30)	- 80/125-30 -
EcoStar plus 20 E /HS	-	1115 €33	80	80-30(30)	- 80/125-30 -
EcoStar plus 25 E/HS / M/HS	-	1115 €33	80	80-30(30)	- 80/125-30 -





	MHG HEIZTECHNIK	Anschlussstück Kesselhersteller	ATEC Anschlussadapter gerade	Verbindungs- leitung	Steigleitung einwandig	Außenwandmontage		
	raumluftunabhängig					konzentrisch	Außenwandmontage	
	ecoGAS Pro 18	-	-	60/100	60-30(30)	-	60/100-30	60/100-30
	ecoGAS Pro 24	-	-	60/100	60-27(25)	80-30(30)	60/100-21	60/100-30
	ecoGAS Pro 30	-	-	60/100	60-19(18)	80-30(30)	60/100-15	60/100-23
	ecoGAS ProX 18/26	-	-	60/100	60-24(22)	80-30(30)	60/100-19	60/100-27
	ecoGAS ProX 30/38	-	-	60/100	60-13(12)	80-30(30)	60/100-11	60/100-15
	ecoGAS 11	-	-	60/100	60-30(30)	-	60/100-26	60/100-26
	ecoGAS 18	-	-	60/100	60-15(10)	80-30(30)	60/100-9	60/100-9
	ecoGAS 24	-	-	80/125	80-28(28)	-	-	80/125-28
	ecoGAS 30	-	-	80/125	80-20(18)	100-30(30)	80/125-20	80/125-20
	ecoGAS 45	-	-	80/125	80-12(11)	100-20(16)	80/125-9	80/125-9
	ecoGAS 18/24	-	-	60/100	60-15(10)	80-30(30)	60/100-9	60/100-9
	ecoGAS 24/28	-	-	80/125	80-28(28)	100-30(30)	80/125-28	80/125-28
	ecoGAS 30/36	-	-	80/125	80-20(18)	100-30(30)	80/125-20	80/125-20
	ecoGAS 45/36	-	-	80/125	80-12(11)	100-20(16)	80/125-9	80/125-9
	ecoGAS Kompakt	-	-	60/100	60-15(10)	80-30(30)	60/100-9	60/100-9
	ProCon E 25	erforderlich	-	80/125	80-24(24)	-	80/125-24	80/125-16
	ProCon E 35	erforderlich	-	80/125	80-24(24)	-	80/125-24	80/125-16
	ecoDUO 15m - 20	erforderlich	-	80/125	80-30(30)	-	80/125-30	-
	ecoDUO 24 - 27m	erforderlich	-	80/125	80-26(24)	-	80/125-16	-
	ecoDUO Gas 15-26 N / F	erforderlich	-	80/125	80-26(24)	-	80/125-16	-
	ecoOEL Pro 30	erforderlich	-	80/125	80-27(25)	100-30(30)	80/125-17	-
	ecoOEL Pro 37 / 38m	erforderlich	-	80/125	80-6(4)	100-30(30)	80/125-5	-
	EcoStar plus 15 E /-HS	-	-	80/125	80-30(30)	-	80/125-30	80/125-30
	EcoStar plus 18 M /-HS	-	-	80/125	80-30(30)	-	80/125-27	80/125-30
	EcoStar plus 20 E /-HS	-	-	80/125	80-30(30)	-	80/125-24	80/125-30
	EcoStar plus 25 E/-HS / M/-HS	-	-	80/125	80-22(22)	-	80/125-22	80/125-30

	PARADIGMA	Anschlussstück Kesselhersteller	ATEC Anschlussadapter gerade	Verbindungs- leitung	Steigleitung einwandig	Außenwandmontage		
	raumluftabhängig					konzentrisch	Außenwandmontage	
	PMA maxi 45	-	-	80	80-25(17)	-	80/125-25	-
	PMA maxi 65	-	-	100	100-25(17)	-	100/150-25	-
	PMA maxi 85	-	-	100	100-22(16)	110-30(30)	100/150-22	-
	PMA maxi 115	-	-	100	100-17(13)	-	100/150-17	-
	Modu Vario NT 15	-	-	60	80-30(30)	-	80/125-30	-
	Modu Vario NT 25	-	-	60	80-30(30)	-	80/125-30	-
	PMA 10 / PMA 15 / PMA 25 / PMA 25 Kombi	-	-	80	80-30(30)	-	80/125-30	-
	PMA 35	-	-	80	80-30(30)	-	80/125-30	-
	PMI 13 / PMI 22	-	-	80	80-30(30)	-	80/125-30	-
	PMI 31	-	-	80	80-30(30)	-	80/125-30	-

	PARADIGMA	Anschlussstück Kesselhersteller	ATEC Anschlussadapter gerade	Verbindungs- leitung	Steigleitung einwandig	Außenwandmontage		
	raumluftunabhängig					konzentrisch	Außenwandmontage	
	PMA maxi 45	-	-	80/125	80-17(11)	100-30(30)	80/125-14	80/125-20
	PMA maxi 65	-	3268 €84	100/150	100-12(10)	125-30(27)	100/150-10	100/150-20
	PMA maxi 85	-	-	100/150	100-11(9)	125-30(27)	100/150-9	100/150-13
	PMA maxi 115	-	-	100/150	125-27(21)	-	100/150-7	100/150-8
	Modu Vario NT 15	-	-	60/100	80-20(20)	-	80/125-15	80/125-17
	Modu Vario NT 25	-	-	60/100	80-20(20)	-	80/125-15	80/125-17
	PMA 10 / PMA 15 / PMA 25 / PMA 25 Kombi	-	-	80/125	80-30(30)	-	80/125-30	80/125-30
	PMA 35	-	-	80/125	80-30(30)	-	80/125-30	80/125-30
	PMI 13 / PMI 22	-	-	80/125	80-30(30)	-	80/125-30	80/125-30
	PMI 31	-	-	80/125	80-30(30)	-	80/125-30	80/125-30

	RADIANT	Anschlussstück Kesselhersteller	ATEC Anschlussadapter gerade	Verbindungs- leitung	Steigleitung einwandig	Außenwandmontage		
	raumluftabhängig					konzentrisch	Außenwandmontage	
	R1K 24/B / R2K 24 / R2KA 24/8 / R2KA 24/100-	-	1115 €33	80	80-30(30)	-	80/125-30	-
	R1K 28/B / R2K 28	-	1115 €33	80	80-30(30)	-	80/125-30	-
	R1K 34/B / R2K 34	-	1115 €33	80	80-30(29)	-	80/125-30	-
	R1K 50	-	1115 €33	80	80-13(11)	100-30(30)	80/125-13	100/150-30
	R1K 100	-	1115 €33	80	110-22(20)	125-30(30)	110/160-22	125/190-30

	RADIANT	Anschlussstück Kesselhersteller	ATEC Anschlussadapter gerade	Verbindungs- leitung	Steigleitung einwandig	Außenwandmontage		
	raumluftunabhängig					konzentrisch	Außenwandmontage	
	R1K 24/B / R2K 24 / R2KA 24/8 / R2KA 24/100	-	1820 €72	80/125	80-30(30)	-	80/125-30	80/125-30
	R1K 28/B / R2K 28	-	1820 €72	80/125	80-30(30)	-	80/125-28	80/125-30
	R1K 34/B / R2K 34	-	1820 €72	80/125	80-21(19)	100-30(30)	80/125-13	80/125-30
	R1K 50	-	1820 €72	80/125	80-7(6)	100-23(21)	80/125-5	80/125-12

	REMEHA	Anschlussstück Kesselhersteller	ATEC Anschlussadapter gerade	Verbindungs- leitung	Steigleitung einwandig	Außenwandmontage		
	raumluftabhängig					konzentrisch	Außenwandmontage	
	Avanta Plus GMR 1024 solo / combi	-	-	80	80-30(30)	-	80/125-30	-
	Calenta Ace 15 DS	-	-	60	60-24(24)	-	60/100-24	-
	Calenta Ace 25 DS / 25 L	-	-	60	60-10(9)	80-30(30)	60/100-10	80/125-30
	Calenta Ace Combi 28 C	-	-	60	60-7(6)	80-30(30)	80/125-30	-
	Calenta Ace 35 DS	-	-	80	80-30(30)	-	80/125-30	-
	CALORA Tower Gas 15S	-	-	60	60-21(20)	-	60/100-21	-
	CALORA Tower Gas 25S	-	-	60	80-30(30)	-	80/125-30	-
	CALORA Tower Gas 35S	-	-	80	80-30(30)	-	80/125-30	-
	Quinta Ace 45	-	-	80	80-30(27)	-	80/125-30	-

**Fortsetzung Remeha raumluftabhängig**

Quinta Ace 65	-	-	-	100	100-30(30)	-	-	100/150-30	-
Quinta Ace 90	-	-	-	100	100-28(24)	-	-	100/150-28	-
Quinta Ace 115	-	-	-	100	100-21(18)	125-30(30)	-	100/150-21	-
Quinta Ace 160	-	4101 €118	-	125	125-23(22)	160-30(30)	-	125/190-23	160/230-30
Tzerra Ace 15 DS	-	-	-	60	60-14(12)	80-30(30)	-	60/100-14	80/125-30
Tzerra Ace 24 DS	-	-	-	60	60-6(6)	80-30(30)	-	60/100-6	80/125-30
Tzerra Ace 28 C	-	-	-	60	80-30(30)	-	-	80/125-30	-
Gas 120 Ace 45	-	-	-	80	80-30(27)	-	-	80/125-30	-
Gas 120 Ace 65	-	-	-	100	100-30(30)	-	-	100/150-30	-
Gas 120 Ace 90	-	-	-	100	100-28(24)	110-30(30)	-	100/150-28	110/160-30
Gas 120 Ace 115	-	-	-	100	100-21(18)	110-30(30)	-	100/150-21	110/160-30
Gas 210-80 ECO PRO	-	4101 €118+4115 €60-	-	125	125-30(30)	-	-	125/190-30	-
Gas 210-120 ECO PRO	-	4101 €118+4115 €60-	-	125	125-30(30)	-	-	125/190-30	-
Gas 210-160 ECO PRO	-	6117 €154+6115 €75-	-	160	125-14(13)	160-30(30)	-	125/190-13	160/230-30
Gas 210-200 ECO PRO	-	6117 €154+6115 €75-	-	160	160-30(30)	-	-	160/230-30	-
Gas 220 Ace 160	-	4101 €118+4115 €60-	-	125	125-23(22)	160-30(30)	-	125/190-23	160/230-30
Gas 220 Ace 200	-	6103 €155+6115 €75-	-	160	160-30(30)	-	-	160/230-30	-
Gas 220 Ace 250	-	6103 €155+6115 €75-	-	160	160-26(25)	200-30	-	160/230-26	200/265-30
Gas 220 Ace 300	-	6103 €155+6115 €75-	-	160	160-13(12)	200-30	-	160/230-12	200/265-30
Gas 320 Ace 285	-	6112 €155	-	160	160-18(18)	200-30	-	160/230-18	200/265-30
Gas 320 Ace 355	-	8102 €155	-	200	200-30	-	-	200/265-30	-
Gas 320 Ace 430	-	8102 €155	-	200	200-30	-	-	200/265-30	-
Gas 320 Ace 500	-	8102 €155	-	200	200-28	-	-	200/265-28	-
Gas 320 Ace 575	-	8102 €155	-	200	200-14	250-30	-	200/265-13	250/315-30
Gas 320 Ace 650	-	-	-	250	200-10	250-30	-	200/265-10	250/315-
Gas 620 Ace 570	-	Sonderteil	-	250	250-30	-	-	250/315-30	-
Gas 620 Ace 710	-	Sonderteil	-	250	250-30	-	-	250/315-30	-
Gas 620 Ace 860	-	Sonderteil	-	250	250-20	-	-	250/315-20	-
Calora Tower Öl 18 LS, 24 LS	-	-	-	80	80-11(10)	100-28(26)	-	80/125-11	100/150-28
Calora Tower Öl 30 LS	-	-	-	80	80-15(13)	100-30(30)	-	80/125-15	100/150-30



REMEHA	Anschlussstück Kesselhersteller	ATEC Anschlussadapter gerade	Verbindungs- leitung	Steigleitung einwandig	konzentrisch	Außenwandmontage
<b>raumluftunabhängig</b>						
Avanta Plus GMR 1024 solo / combi	-	-	80/125	80-19(18)	100-30(30)	80/125-13 80/125-30 -
Calenta Ace 15 DS	-	-	60/100	60-17(16)	80-30(30)	60/100-13 60/100-24 -
Calenta Ace 25 DS / 25 L	-	-	60/100	60-7(6)	80-30(30)	60/100-5 60/100-9 80/125-30
Calenta Ace Combi 28 C	-	-	60/100	80-26(24)	-	80/125-18 80/125-30 -
Calenta Ace 35 DS	-	-	80/125	80-26(24)	-	80/125-18 80/125-30 -
CALORA Tower Gas 15S	-	-	60/100	60-18(17)	-	60/100-13 60/100-22 -
CALORA Tower Gas 25S	-	-	60/100	80-22(21)	-	80/125-16 80/125-30 -
CALORA Tower Gas 35S	-	-	80/125	80-26(24)	-	80/125-18 80/125-30 -
Quinta Ace 45	-	-	80/125	80-18(16)	100-30(30)	80/125-13 80/125-30 -
Quinta Ace 65	-	-	100/150	100-12(11)	110-23(22)	100/150-9 100/150-30 -
Quinta Ace 90	-	-	100/150	100-11(10)	110-20(19)	100/150-8 100/150-27 -
Quinta Ace 115	-	-	100/150	100-8(7)	125-26(25)	100/150-7 100/150-19 125/190-30
Quinta Ace 160	-	-	Auf Anfrage	-	-	-
Tzerra Ace 15 DS	-	-	60/100	60-8(7)	80-30(30)	60/100-7 60/100-13 80/125-30
Tzerra Ace 24 DS	-	-	60/100	80-22(20)	-	80/125-15 60/100-6 80/125-30
Tzerra Ace 28 C	-	-	60/100	80-27(25)	-	80/125-19 80/125-30 -
Gas 120 Ace 45	-	-	80/125	80-17(16)	100-30(30)	80/125-12 80/125-30 -
Gas 120 Ace 65	-	-	100/150	100-11(10)	110-21(20)	100/150-8 100/150-30 -
Gas 120 Ace 90	-	-	100/150	100-9(9)	110-18(17)	100/150-7 100/150-26 110/160-30
Gas 120 Ace 115	-	-	100/150	110-14(13)	125-23(22)	100/150-5 100/150-19 110/160-30
Calora Tower Öl 18 LS, 24 LS	-	-	80/125	80-10(10)	100-26(25)	80/125-7 80/125-14 100/150-30
Calora Tower Öl 30 LS	-	-	80/125	80-9(8)	100-30(30)	80/125-6 80/125-15 100/150-30



SCHEER	Anschlussstück Kesselhersteller	ATEC Anschlussadapter gerade	Verbindungs- leitung	Steigleitung einwandig	konzentrisch	Außenwandmontage
<b>raumluftunabhängig</b>						
Öltherme ALUCCondens 14/17/19/23 kW	-	1270 €94	80/125	80-30(24)	-	80/125-24 80/125-30 -
Öltherme DUOCondens/Wärmezentrum 12/14/17/19 kW	-	1270 €94	80/125	80-30(30)	-	80/125-30 80/125-30 -
Öltherme DUOCondens/Wärmezentrum 17-25 kW	-	1270 €94	80/125	80-30(24)	-	80/125-24 80/125-30 -
Öltherme DUOCondens/Wärmezentrum 20-30 kW	-	1270 €94	80/125	80-25(19)	-	80/125-18 80/125-30 -



SOLVIS	Anschlussstück Kesselhersteller	ATEC Anschlussadapter gerade	Verbindungs- leitung	Steigleitung einwandig	Außenwandmontage
<b>raumluftabhängig</b>					
SolvisBen SBG 10	-	0130 €32	60	60-30(30)	60/100-30 -
SolvisBen SBG 18	-	0130 €32	60	60-29(26)	60/100-29 -
SolvisBen SBG 25	-	-	80	80-30(30)	80/125-30 -
SolvisBen SBG 30	-	-	80	80-30(30)	80/125-30 -
SolvisMax SX-LN 10	-	0130 €32	60	60-30(30)	60/100-30 -
SolvisMax SX-LN 18	-	0130 €32	60	60-29(26)	60/100-29 -
SolvisMax SX-LN 25	-	-	80	80-30(30)	80/125-30 -
SolvisMax SX-LN 30	-	-	80	80-30(30)	80/125-30 -
SolvisBen Öl SBO 10/17	-	-	80	80-30(30)	80/125-30 -
SolvisBen Öl SBO 14/23	-	-	80	80-30(30)	80/125-30 -
SolvisMax SÖ-BW 17	-	-	80	80-30(30)	80/125-30 -
SolvisMax SÖ-BW 23	-	-	80	80-30(27)	80/125-30 -
SolvisMax SÖ-BW 28	-	-	80	80-30(22)	80/125-30 -



SOLVIS	Anschlussstück Kesselhersteller	ATEC Anschlussadapter gerade	Verbindungs- leitung	Steigleitung einwandig	konzentrisch	Außenwandmontage
<b>raumluftunabhängig</b>						
SolvisBen SBG 10	-	0866 €61	60/100	60-30(30)	60/100-30	60/100-30 -
SolvisBen SBG 18	-	0866 €61	60/100	60-25(23)	60/100-18	60/100-29 -

**Fortsetzung Solvis raumluftunabhängig**

SolvisBen SBG 25	-	-	-	80/125	80-30(30)	-	80/125-30	80/125-30	-
SolvisBen SBG 30	-	-	-	80/125	80-30(30)	-	80/125-30	80/125-30	-
SolvisMax SX-LN 10	-	0866 €61	-	60/100	60-30(30)	-	60/100-30	60/100-30	-
SolvisMax SX-LN 18	-	0866 €61	-	60/100	60-25(23)	-	60/100-18	60/100-29	-
SolvisMax SX-LN 25	-	-	-	80/125	80-30(30)	-	80/125-30	80/125-30	-
SolvisMax SX-LN 30	-	-	-	80/125	80-30(30)	-	80/125-30	80/125-30	-
SolvisBen Öl SBO 10/17	-	-	-	80/125	80-30(30)	-	80/125-30	80/125-30	-
SolvisBen Öl SBO 14/23	-	-	-	80/125	80-30(30)	-	80/125-30	80/125-30	-
SolvisMax SÖ-BW 17	-	-	-	80/125	80-30(30)	-	80/125-30	80/125-30	-
SolvisMax SÖ-BW 23	-	-	-	80/125	80-24(19)	-	80/125-19	80/125-30	-
SolvisMax SÖ-BW 28	-	-	-	80/125	80-20(16)	-	80/125-16	80/125-28	-



VAILLANT	Anschlussstück Kesselhersteller	ATEC Anschlussadapter gerade		Verbindungs- leitung	Steigleitung einwandig		Außenwandmontage		
<b>raumluftabhängig</b>									
ecoCraft VKK 806/3-E	-	4101 €118+4115 €60-	-	125	125-30(30)	-	125/190-30	-	-
ecoCraft VKK 1206/3-E	-	4101 €118+4115 €60-	-	125	125-30(28)	-	125/190-30	-	-
ecoCraft VKK 1606/3-E	-	6101 €133+6115 €75-	-	160	160-30(30)	-	160/230-30	-	-
ecoCraft VKK 2006/3-E	-	6103 €155+6115 €75-	-	160	160-30(30)	-	160/230-30	-	-
ecoCraft VKK 2406/3-E	-	8115 €77	-	200	200-30	160-30(26)	160/230-30	-	-
ecoCraft VKK 2806/3-E	-	8115 €77	-	200	200-30	-	200/265-30	-	-
ecoVIT VKK 226 bis 476	-	1115 €33	-	80	80-30(30)	-	80/125-20	-	-
icoVIT exklusiv VKO 156/3-7	-	1115 €33	-	80	80-30(30)	-	80/125-20	-	-
icoVIT exklusiv VKO 256/3-7S	-	-	-	80	80-30(30)	-	80/125-30	-	-
ico VIT exklusiv VKO 356/3-7	-	1115 €33	-	80	80-28(18)	-	80/125-28	-	-



VISSMANN	Anschlussstück Kesselhersteller	ATEC Anschlussadapter gerade		Verbindungs- leitung	Steigleitung einwandig		Außenwandmontage		
<b>raumluftabhängig</b>									
Vitocrossal 200 CIB 80	-	3106 €189	-	110	110-27(24)	125-30(30)	110/160-26	125/190-30	-
Vitocrossal 200 CIB 120	-	4113 €161	-	125	125-20(19)	160-30(30)	125/190-20	-	-
Vitocrossal 200 CIB 160	-	6103 €155	-	160	160-30(30)	-	160/230-30	-	-
Vitocrossal 200 CIB 200	-	6103 €155	-	160	160-30(30)	-	160/230-30	-	-
Vitocrossal 200 CIB 240	-	-	-	200	200-30	-	200/265-30	-	-
Vitocrossal 200 CIB 280	-	-	-	200	200-30	-	200/265-30	-	-
Vitocrossal 200 CIB 318	-	-	-	200	200-30	-	200/265-30	-	-
Vitocrossal 200 CM2 400	-	8102 €155	-	200	200-30	-	200/265-30	-	-
Vitocrossal 200 CM2 500 / CM2 620	-	-	-	250	250-30	-	250/315-30	-	-
Vitocrossal 300 CM3C 87	-	4104 €118	-	125	125-30(29)	-	125/190-30	-	-
Vitocrossal 300 CM3C 115	-	4104 €118	-	125	125-22(14)	160-30(30)	125/190-22	160/230-30	-
Vitocrossal 300 CM3C 142	-	-	-	160	160-30(30)	-	160/230-30	-	-
Vitocrossal 300 CM3C 186	-	6103 €155	-	160	160-30(23)	-	160/230-30	-	-
Vitocrossal 300 CM3C 246	-	-	-	200	200-30	-	200/265-30	-	-
Vitocrossal 300 CM3C 311	-	-	-	200	200-30	-	200/265-30	-	-
Vitocrossal 300 CT3B 187	-	6118 €155+6115 €75	-	160	160-30(23)	-	160/230-30	-	-
Vitocrossal 300 CT3B 248	-	8115 €77	-	200	160-17	200-30	160/230-16	200/265-30	-
Vitocrossal 300 CT3B 314	-	8115 €77	-	200	200-30	-	200/265-30	-	-
Vitocrossal 300 CT3B 408	-	9115 €110	-	250	250-30	-	250/315-30	-	-
Vitocrossal 300 CT3B 508	-	9115 €110	-	250	250-30	-	250/315-30	-	-
Vitocrossal 300 CT3B 635	-	9115 €110	-	250	250-30	-	250/315-30	-	-
Vitocrossal 300 CT3U 400	-	8102 €155+8115 €77	-	200	200-20	250-30	200/260-20	250/315-30	-
Vitocrossal 300 CT3U 500	-	9115 €110	-	250	250-30	-	250/315-30	-	-
Vitocrossal 300 CT3U 630	-	9115 €110	-	250	250-30	-	250/315-30	-	-
Vitocrossal 300 CU3A 13	-	0130 €32	-	60	60-28(18)	-	60/100-28	-	-
Vitocrossal 300 CU3A 19	-	-	-	80	80-30(30)	-	80/125-30	-	-
Vitocrossal 300 CU3A 26	-	-	-	80	80-30(26)	-	80/125-30	-	-
Vitocrossal 300 CU3A 35	-	-	-	80	80-20(13)	100-30(30)	80/125-20	-	-
Vitocrossal 300 CU3A 45	-	3115 €56	-	110	110-30(30)	100-30(30)	110/160-30	100/150-30	-
Vitocrossal 300 CU3A 60	-	3115 €56	-	110	110-30(29)	-	110/160-30	-	-
Vitodens 100-W B1HC 19	-	-	-	60	60-20(18)	80-30(30)	60/100-20	80/125-30	-
Vitodens 100-W B1HC / B1KC 26	-	-	-	60	60-9(8)	80-30(30)	60/100-8	80/125-30	-
Vitodens 100-W B1HF 11 / 19	-	-	-	60	60-30(30)	-	60/100-30	-	-
Vitodens 100-W B1HF 25	-	-	-	60	60-26(23)	-	60/100-26	-	-
Vitodens 100-W B1HF 32	-	-	-	60	60-13(11)	80-30(30)	60/100-13	80/125-30	-
Vitodens 200-W B2HB / 222-F B2TB/B2SB / 222-W B2LB 13	-	-	-	60	60-30(30)	-	60/100-30	-	-
Vitodens 200-W B2HB / 222-F B2TB/B2SB / 222-W B2LB 19	-	-	-	60	60-30(30)	-	60/100-30	-	-
Vitodens 200-W B2KB / 222-F B2TB/B2SB / 222-W B2LB 26	-	-	-	60	60-14(12)	80-30(30)	60/100-13	80/125-30	-
Vitodens 200-W B2KB / 222-F B2TB / 222-W B2LB 35	-	-	-	60	80-30(30)	-	80/125-30	-	-
Vitodens 200-W B2HB 26	-	-	-	60	60-21(21)	80-30(30)	60/100-23	80/125-30	-
Vitodens 200-W B2HB 35	-	-	-	60	80-30(30)	-	80/125-30	-	-
Vitodens 200-W B2HF / 222-F B2TF-B2SF / 222-F B2LF 11	-	-	-	60	60-30(30)	-	60/100-30	-	-
Vitodens 200-W B2HF / 222-F B2TF-B2SF / 222-F B2LF 19	-	-	-	60	60-30(30)	-	60/100-30	-	-
Vitodens 200-W B2HF 25	-	-	-	60	60-27(24)	-	60/100-27	-	-
Vitodens 200-W B2HF 32	-	-	-	60	60-14(12)	80-30(30)	60/100-14	80/125-30	-
Vitodens 200-W B2KF 19	-	-	-	60	60-17(15)	80-30(30)	60/100-17	80/125-30	-
Vitodens 200-W B2KF 25	-	-	-	60	60-12(10)	80-30(30)	60/100-12	80/125-30	-
Vitodens 200-W B2KF 32	-	-	-	60	60-9(8)	80-30(30)	60/100-9	80/125-30	-
Vitodens 200-W 49	-	-	-	80	80-30(22)	-	80/125-30	-	-
Vitodens 200-W 60	-	-	-	80	80-17(11)	100-30(30)	80/125-17	-	-
Vitodens 200-W 80	-	2232 €51	-	100	100-30(30)	-	100/150-30	-	-
Vitodens 200-W 99	-	-	-	110	110-30(30)	100-30(26)	110/160-30	100/150-30	-
Vitodens 200-W 120	-	-	-	110	110-26(17)	125-30(30)	110/160-26	-	-
Vitodens 200-W 150	-	-	-	110	110-16(10)	125-30(24)	110/160-16	-	-
Vitodens 222-F B2TF-B2SF / 222-F B2LF 25	-	-	-	60	60-14(12)	80-30(30)	60/100-14	80/125-30	-
Vitodens 222-F B2TF-B2SF / 222-F B2LF 32	-	-	-	60	80-30(30)	-	80/125-30	-	-
Vitodens 242-F B2UF 13 / 333-F B3TG / 343-F B3UG 11	-	-	-	60	60-30(30)	-	60/100-30	-	-
Vitodens 242-F B2UF 19 / 333-F B3TG / 343-F B3UG 19	-	-	-	60	60-30(30)	-	60/100-30	-	-
Vitodens 242-F B2UB 26 / 333-F B3TB 26	-	-	-	60	60-23(21)	80-30(30)	60/100-23	80/125-30	-
Vitodens 300-W B3HG / Vitosolar 300-F B3HB 11	-	-	-	60	60-30(30)	-	60/100-30	-	-

### Fortsetzung Viessmann raumluftabhängig

Vitodens 300-W B3HG / Vitosolar 300-F B3HB 19	-	-	60	60-30(30)	-	-	60/100-30	-
Vitodens 300-W B3HG / Vitosolar 300-F B3HB 26	-	-	60	60-26(23)	80-30(30)	-	60/100-26	80/125-30
Vitodens 300-W B3HG / Vitosolar 300-F B3HB 35	-	-	60	60-11(9)	80-30(30)	-	60/100-10	80/125-30
Vitodens 333-F B3TG 26	-	-	60	60-23(21)	80-30(30)	-	60/100-23	80/125-30
Vitodens 333-F B3TG 32	-	-	60	80-30(30)	-	-	80/125-30	-
Vitoladens 300-C BC3B / Vitoladens 300-C J3RB 18 / 22	1115 €33	-	80	80-30(30)	-	-	80/125-30	-
Vitoladens 300-C BC3B / Vitoladens 300-C J3RB 27	1115 €33	-	80	80-30(28)	-	-	80/125-30	-
Vitorondens 200-T BR2A 20	-	-	80	80-30(30)	-	-	80/125-30	-
Vitorondens 200-T BR2A 24	-	-	80	80-30(30)	-	-	80/125-30	-
Vitorondens 200-T BR2A 28	-	-	80	80-30(25)	-	-	80/125-30	-
Vitorondens 200-T BR2A 33	-	-	80	80-30(27)	-	-	80/125-30	-
Vitorondens 200-T BR2A 40	-	2232 €51	100	100-30(30)	-	-	100/150-30	-
Vitorondens 200-T BR2A 50	-	2232 €51	100	100-30(27)	-	-	100/150-30	-
Vitorondens 200-T J2RA 63	-	-	110	110-30(30)	-	-	110/160-30	-
Vitorondens 200-T J2RA 80	-	-	110	110-26(24)	-	-	110/160-26	-
Vitorondens 200-T J2RA 100	-	-	110	110-13(12)	125-30(30)	-	110/160-13	125/190-30
Vitoradial 300-T VR3 97	-	4113 €161	125	125-30(30)	-	-	125/190-30	-
Vitoradial 300-T VR3 124 / 151	-	6103 €155+6115 €75	160	160-30(30)	-	-	160/230-30	-
Vitoradial 300-T VR3 194	-	6103 €155+6115 €75	160	160-30(30)	-	-	160/230-30	-
Vitoradial 300-T VR3 254 / 323	-	8115 €77	200	200-30	-	-	200/265-30	-
Vitoradial 300-T VR3 420	-	8115 €77	200	200-27	-	-	200/265-27	-
Vitoradial 300-T VR3 538	-	9101 €187+9115 €110	250	250-30	-	-	250/315-30	-



VISSMANN raumluftunabhängig	Anschlussstück Kesselhersteller	ATEC Anschlussadapter gerade	Verbindungs- leitung	Steigleitung einwandig	konzentrisch	Außenwandmontage
Vitocrossal 300 CU3A 13	-	0866 €61	60/100	60-22(15)	60/100-17	60/100-26
Vitocrossal 300 CU3A 19	-	-	80/125	80-30(30)	80/125-30	80/125-30
Vitocrossal 300 CU3A 26	-	-	80/125	80-24(18)	80/125-18	80/125-30
Vitocrossal 300 CU3A 35	-	-	80/125	80-13(9)	100-30(27)	80/125-16
Vitocrossal 300 CU3A 45	-	2267 €86	110/160	110-30(30)	110/160-24	110/160-30
Vitocrossal 300 CU3A 60	-	2267 €86	110/160	110-21(17)	125-30(29)	110/160-12
Vitodens 100-W B1HC 19	-	-	60/100	60-18(16)	80-30(30)	60/100-19
Vitodens 100-W B1HC / B1KC 26	-	-	60/100	60-7(6)	80-30(30)	60/100-4
Vitodens 100-W B1HF 11 / 19	-	-	60/100	60-30(30)	-	60/100-30
Vitodens 100-W B1HF 25	-	-	60/100	60-23(20)	-	60/100-16
Vitodens 100-W B1HF 32	-	-	60/100	60-10(9)	80-30(30)	60/100-7
Vitodens 200-W B2HB / 222-F B2TB/B2SB / 222-W B2LB 13	0805 €31	-	60/100	60-30(30)	-	60/100-30
Vitodens 200-W B2HB / 222-F B2TB/B2SB / 222-W B2LB 19	0805 €31	-	60/100	60-30(30)	-	60/100-30
Vitodens 200-W B2KB / 222-F B2TB/B2SB / 222-W B2LB 26	0805 €31	-	60/100	60-11(10)	80-30(30)	60/100-8
Vitodens 200-W B2KB / 222-F B2TB / 222-W B2LB 35	0805 €31	-	60/100	80-30(30)	-	80/125-26
Vitodens 200-W B2HB 26	0805 €31	-	60/100	60-20(18)	80-30(30)	60/100-14
Vitodens 200-W B2HB 35	0805 €31	-	60/100	80-30(30)	-	80/125-30
Vitodens 200-W B2HF / 222-F B2TF-B2SF / 222-F B2LF 11	0805 €31	-	60/100	60-30(30)	-	60/100-30
Vitodens 200-W B2HF / 222-F B2TF-B2SF / 222-F B2LF 19	0805 €31	-	60/100	60-30(30)	-	60/100-30
Vitodens 200-W B2HF 25	0805 €31	-	60/100	60-24(22)	-	60/100-16
Vitodens 200-W B2HF 32	0805 €31	-	60/100	60-12(11)	80-30(30)	60/100-7
Vitodens 200-W B2KF 19	0805 €31	-	60/100	60-15(13)	80-30(30)	60/100-10
Vitodens 200-W B2KF 25	0805 €31	-	60/100	60-10(8)	80-30(30)	60/100-7
Vitodens 200-W B2KF 32	0805 €31	-	60/100	60-7(7)	80-30(30)	80/125-25
Vitodens 200-W 49	-	-	80/125	80-23(17)	100-30(30)	80/125-16
Vitodens 200-W 60	-	-	80/125	100-30(29)	-	100/150-24
Vitodens 200-W 80	2267 €86	-	110/160	110-30(28)	100-19(15)	100/150-14
Vitodens 200-W 99	2267 €86	-	110/160	110-22(16)	-	110/160-11
Vitodens 200-W 120	2267 €86	-	110/160	110-13(9)	125-24(19)	-
Vitodens 200-W 150	2267 €86	-	110/160	125-14(11)	-	-
Vitodens 222-F B2TF-B2SF / 222-F B2LF 25	0805 €31	-	60/100	60-12(11)	80-30(30)	60/100-9
Vitodens 222-F B2TF-B2SF / 222-F B2LF 32	0805 €31	-	60/100	80-30(30)	-	80/125-30
Vitodens 242-F B2UF 13 / 333-F B3TG / 343-F B3UG 11	0805 €31	-	60/100	60-30(30)	-	60/100-30
Vitodens 242-F B2UF 19 / 333-F B3TG / 343-F B3UG 19	0805 €31	-	60/100	60-30(30)	-	60/100-30
Vitodens 242-F B2UB 26 / 333-F B3TB 26	0805 €31	-	60/100	60-20(18)	80-30(30)	60/100-14
Vitodens 300-W B3HG / Vitosolar 300-F B3HB 11	0805 €31	-	60/100	60-30(30)	-	60/100-30
Vitodens 300-W B3HG / Vitosolar 300-F B3HB 19	0805 €31	-	60/100	60-30(30)	-	60/100-30
Vitodens 300-W B3HG / Vitosolar 300-F B3HB 26	0805 €31	-	60/100	60-23(21)	80-30(30)	60/100-16
Vitodens 300-W B3HG / Vitosolar 300-F B3HB 35	0805 €31	-	60/100	60-9(8)	80-30(30)	60/100-6
Vitodens 333-F B3TG 26	0805 €31	-	60/100	60-20(18)	80-30(30)	60/100-14
Vitodens 333-F B3TG 32	0805 €31	-	60/100	80-30(30)	-	80/125-30
Vitoladens 300-C BC3B / Vitoladens 300-C J3RB 18 / 22	1820 €72	-	80/125	80-30(30)	-	80/125-30
Vitoladens 300-C BC3B / Vitoladens 300-C J3RB 27	1820 €72	-	80/125	80-30(30)	-	80/125-30
Vitorondens 200-T BR2A 20	erforderlich	-	80/125	80-30(30)	-	80/125-30
Vitorondens 200-T BR2A 24	erforderlich	-	80/125	80-30(30)	-	80/125-30
Vitorondens 200-T BR2A 28	erforderlich	-	80/125	80-30(30)	-	80/125-30
Vitorondens 200-T BR2A 33	erforderlich	-	80/125	80-30(30)	-	80/125-30
Vitorondens 200-T BR2A 40	erforderlich	2267 €86	100/150	100-30(30)	-	100/150-30
Vitorondens 200-T BR2A 50	erforderlich	2267 €86	100/150	100-30(27)	-	100/150-30



WEISHAUPT raumluftabhängig	Anschlussstück Kesselhersteller	ATEC Anschlussadapter gerade	Verbindungs- leitung	Steigleitung einwandig	Außenwandmontage
WTC-GW 15-B	-	1115 €33	80	80-30(30)	80/125-30
WTC-GW 25-B	-	1115 €33	80	80-30(30)	80/125-30
WTC-GW 32-B	-	1115 €33	80	80-30(30)	80/125-30
WTC-GW 45-B	480 000 05 322	1115 €33	80	80-11(7)	100-30(30)
WTC-GW 60-B	480 000 05 322	1115 €33	80	100-30(25)	-
WTC-GW 80-A	480 000 14952	-	110	110-30(30)	-
WTC-GW 100-A	480 000 14952	-	110	110-30(30)	-
WTC-GB 15-B	-	0130 €32+1115 €33-	60	60-26(23)	60/100-26
WTC-GB 25-B	-	1115 €33	80	80-30(30)	80/125-30

**Fortsetzung Weishaupt raumluftunabhängig**

WTC-GB 120-A	480 000 11 732	4115 €60	-	125	125-30(30)	110-21(14)	-	125/190-30	-
WTC-GB 170-A	480 000 11 732	4115 €60	-	125	125-23(15)	160-30(30)	-	125/190-22	-
WTC-GB 210-A	480 000 11 782	6115 €75	-	160	160-30(30)	-	-	160/230-30	-
WTC-GB 250-A	480 000 11 782	6115 €75	-	160	160-30(30)	-	-	160/230-30	-
WTC-GB 300-A	480 000 11 782	6115 €75	-	160	160-30(23)	-	-	160/230-30	-
WTC-OB 18-B	-	1115 €33	-	80	80-30(30)	-	-	80/125-30	-
WTC-OB 25-B	480 000 53 22	1115 €33	-	80	80-30(30)	-	-	80/125-30	-
WTC-OB 30-B	480 000 53 22	1115 €33	-	80	80-30(24)	-	-	80/125-30	-
WTC-OB 35-B	480 000 53 22	1115 €33	-	80	80-26(17)	100-30(30)	-	80/125-26	-
WTC-OB 45-A	480 000 53 22	1115 €33	-	80	100-30(23)	-	-	100/150-30	-



WEISHAUPT	Anschlussstück Kesselhersteller	ATEC Anschlussadapter gerade		Verbindungs- leitung	Steigleitung einwandig		konzentrisch	Außenwandmontage	
<b>raumluftunabhängig</b>									
WTC-GW 15-B	-	1820 €72	-	80/125	80-30(30)	-	80/125-30	80/125-30	-
WTC-GW 25-B	-	1220 €67	-	80/125	80-30(30)	-	80/125-29	80/125-30	-
WTC-GW 32-B	-	1220 €67	-	80/125	80-30(30)	-	80/125-30	80/125-30	-
WTC-GW 45-B	480 000 05 322	1220 €67	-	80/125	100-21(17)	110-30(28)	80/125-4	80/125-7	100/150-30
WTC-GW 60-B	480 000 05 322	1220 €67	-	80/125	100-16(12)	110-29(22)	100/150-11	100/150-27	-
WTC-GW 80-A	480 000 14952	-	-	110/160	110-28(27)	-	-	110/160-30	-
WTC-GW 100-A	480 000 14952	-	-	110/160	110-26(25)	-	-	110/160-30	-
WTC-GB 15-B	-	1866 €61+1820 €72-	-	60/100	60-22(20)	-	60/100-15	60/100-26	-
WTC-GB 25-B	-	1820 €72	-	80/125	80-30(30)	-	80/125-30	80/125-30	-
WTC-GB 120-A	480 000 11 732	4115 €60	-	125	125-30(28)	-	-	125/190-30	-
WTC-GB 170-A	480 000 11 732	4115 €60	-	125	125-15(10)	160-30(30)	-	160/230-30	-
WTC-GB 210-A	480 000 11 782	6115 €75	-	160	160-30(18)	-	-	160/230-30	-
WTC-GB 250-A	480 000 11 782	6115 €75	-	160	160-20(12)	200-30	-	160/230-19	-
WTC-GB 300-A	480 000 11 782	8107 €142+8115 €77-	-	200	200-30	-	-	200/265-30	-
WTC-OB 18-B	-	1220 €67	-	80/125	80-30(28)	-	80/125-27	80/125-30	-
WTC-OB 25-B	480 000 53 22	1220 €67	-	80/125	80-30(26)	-	80/125-25	80/125-30	-
WTC-OB 30-B	480 000 53 22	1220 €67	-	80/125	80-23(17)	100-30(30)	80/125-17	80/125-30	-
WTC-OB 35-B	480 000 53 22	1220 €67	-	80/125	80-17(13)	100-30(30)	100/150-30	80/125-22	100/150-30
WTC-OB 45-A	480 000 53 22	1220 €67	-	80/125	110-22(18)	-	110/160-14	110/160-28	-



WOLF	Anschlussstück Kesselhersteller	ATEC Anschlussadapter gerade		Verbindungs- leitung	Steigleitung einwandig		Außenwandmontage		
<b>raumluftabhängig</b>									
CGB-2 14/ CGS-2 14/ CGW-2 14	-	-	-	60	60-30(30)	-	-	60/100-30	-
CGB-2 20/ CGB-2K 20/ CGS-2 20/ CGW-2 20	-	-	-	60	60-25(22)	80-30(30)	-	60/100-25	80/125-30
CGB-2 24/ CGB-2K 24/ CGS-2 24/ CGW-2 24	-	-	-	60	60-21(17)	80-30(30)	-	60/100-21	80/125-30
CGB-2 38	-	-	-	80	80-30(30)	-	-	80/125-30	-
CGB-2 55	-	-	-	80	80-17(15)	80/125-17	100-30(30)	100/150-30	-
CGB 35 / CGB-K-40-35	-	-	-	80	80-30(30)	-	-	80/125-30	-
CGB 50	-	-	-	80	80-23(20)	100-30(30)	-	80/125-23	100/150-30
CGB-2 75	-	-	-	110	110-30(30)	100-26(22)	-	110/160-30	100/150-26
CGB-2 100	-	-	-	110	110-30(30)	-	-	100/150-30	-
CSZ-2 14/300R	-	-	-	60	60-30(30)	-	-	60/100-30	-
CSZ-2 20/300R	-	-	-	60	60-25(22)	80-30(30)	-	60/100-25	80/125-30
CSZ-2 24/300R	-	-	-	60	60-21(17)	80-30(30)	-	60/100-21	80/125-30
MGK-2-130	-	4104 €118	-	125	125-30(30)	-	-	125/190-30	-
MGK-2-170	-	6115 €75	-	160	160-30(30)	-	-	160/230-30	-
MGK-2-210	-	6115 €75	-	160	160-30(30)	-	-	160/230-30	-
MGK-2-250	-	6115 €75	-	160	160-30(30)	-	-	160/230-30	-
MGK-2-300	-	6103 €155+6115 €75	-	160	160-23(22)	200-30	-	160/230-23	200/265-30
MGK-2-390	-	8102 €155+8115 €77	-	200	200-30	-	-	200/265-30	-
MGK-2-470	-	8102 €155+8115 €77	-	200	200-30	-	-	200/265-30	-
MGK-2-550	-	8102 €155+8115 €77	-	200	200-21	250-30	-	200/265-21	250/315-30
MGK-2-630	-	8102 €155+8115 €77	-	200	200-13	250-30	-	200/265-13	250/315-30
MGK-2-800	-	9115 €110	-	250	250-30	-	-	250/315-30	-
TGB-2-20	-	-	-	80	80-30(30)	-	-	80/125-30	-
TGB-2-30	-	-	-	80	80-30(30)	-	-	80/125-30	-
TOB-TS 18	-	-	-	80	80-30(30)	-	-	80/125-30	-
COB 15/ COB 15 TS/ COB-2 15/ COB-2-15 TS	-	-	-	80	60-21(20)	80-30(30)	-	60/100-21	80/125-30
COB 20/ COB 20 TS/ COB-2 20/ COB-2 20 TS	-	-	-	80	80-30(30)	-	-	80/125-30	-
COB 29/ COB 29 TS/ COB-2 29/ COB-2 29 TS	-	-	-	80	80-30(30)	-	-	80/125-30	-
COB 40/ COB-2 40	-	2232 €51	-	100	100-30(30)	-	-	100/150-30	-

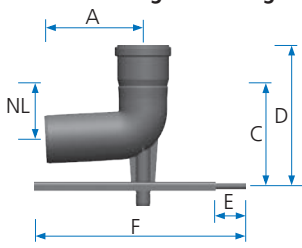
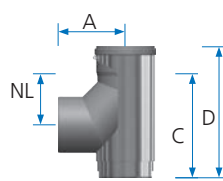
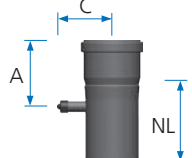
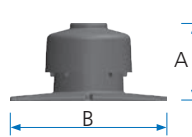
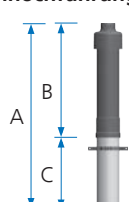
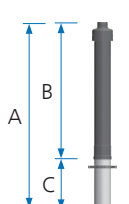
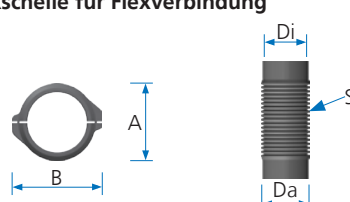
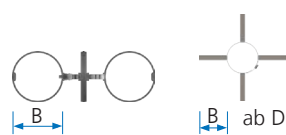

WOLF	Anschlussstück Kesselhersteller	ATEC Anschlussadapter gerade		Verbindungs- leitung	Steigleitung einwandig		konzentrisch	Außenwandmontage	
<b>raumluftunabhängig</b>									
CGB-2 14/ CGS-2 14/ CGW-2 14	-	-	-	60/100	60-30(30)	-	60/100-29	60/100-30	-
CGB-2 20/ CGB-2K 20/ CGS-2 20/ CGW-2 20	-	-	-	60/100	60-19(17)	80-30(30)	60/100-14	60/100-25	80/125-30
CGB-2 24/ CGB-2K 24/ CGS-2 24/ CGW-2 24	-	-	-	60/100	60-16(14)	80-30(30)	60/100-12	60/100-20	80/125-30
CGB-2 38	-	-	-	80/125	80-28(27)	-	80/125-18	80/125-30	-
CGB-2 55	-	-	-	80/125	80-11(10)	100-30(30)	80/125-6	80/125-11	100/150-30
CGB 35 / CGB-K-40-35	-	-	-	80/125	80-23(22)	100-30(30)	80/125-17	80/125-30	-
CGB 50	-	-	-	80/125	80-12(11)	100-30(30)	80/125-9	80/125-22	100/150-30
CGB-2 75	-	-	-	110/160	110-18(17)	-	110/160-10	110/160-30	100/150-25
CGB-2 100	-	-	-	110/160	110-20(19)	125-30(30)	110/160-11	110/160-30	-
CSZ-2 14/300R	-	-	-	60/100	60-30(30)	-	60/100-29	60/100-30	-
CSZ-2 20/300R	-	-	-	60/100	60-19(17)	80-30(30)	60/100-14	60/100-25	80/125-30
CSZ-2 24/300R	-	-	-	80/125	60-16(14)	80-30(30)	60/100-12	60/100-20	80/125-30
TGB-2-20	-	-	-	80/125	80-30(30)	-	80/125-30	-	-
TGB-2-30	-	-	-	80/125	80-30(30)	-	80/125-30	-	-
TOB-TS 18	-	-	-	80/125	80-30(30)	-	80/125-20	80/125-30	-
COB 15/ COB 15 TS/ COB-2 15/ COB-2-15 TS	-	-	-	80/125	60-18(16)	80-30(30)	60/100-13	60/100-22	80/125-30
COB 20/ COB 20 TS/ COB-2 20/ COB-2 20 TS	-	-	-	80/125	80-30(30)	-	80/125-27	80/125-30	-
COB 29/ COB 29 TS/ COB-2 29/ COB-2 29 TS	-	-	-	80/125	80-28(26)	-	80/125-20	80/125-30	-
COB 40/ COB-2 40	-	2221 €123	-	100/150	100-30(30)	-	100/150-30	100/150-30	-

Alle Maße in mm		Muffe Ø	DN	60	80	100	110	125	160	200	250
		Durchmesser außen	D	60	80	100	110	125	160	200	250
		Durchmesser innen	Di	56	76	96	105	119	153	193	242
		Muffenaußenmaß	MA	75	94	115	128	146	184	220	274
<b>Schachteinführung mit Auflager</b>											
		A	98	161	171	123	134	180			
		NL	44	95	105	67	76	93			
		C	100	172	192	160	186	208			
		D	160	232	252	220	255	307			
		E	50	50	50	50	70	70			
		F	350	350	350	350	420	420			
<b>Schachteinführungsstütze</b>											
		A								230	230
		NL								196	163
		C								381	375
		D								477	475
<b>Messelement/Kesselanschluss</b>											
		A	98	100	98	98	120	120	140	150	
		NL	122	124	122	122	257	256	204	200	
		C	72	83	96	103	109	127	147	172	
<b>Mündungs-Set Kunststoff</b>											
		A	177	177	177	177	193	193	193	221	
		B	360	360	360	360	400	400	440	500	
<b>Dachhochführung, 650 mm</b>											
		A	1120	1040							
		B	614	636							
		C	506	404							
<b>Dachhochführung, 1100 mm</b>											
		A		1490	1420	1500					
		B		1086	931	990					
		C		404	489	510					
<b>Fixschelle für Flexverbindung</b>											
		A	82	102	121	134	152	188			
		B	100	118	138	153	172	207			
		Di	53	74	94	102	118	154			
		Da	64	85	105	113	131	165			
		S	1,1	1,1	1,1	1,1	1,3	1,3			
		S= Wandstärke Flexrohr in mm									
<b>Abstandhalter</b>											
		B*	105	105	105	105	105	105	180	180	
		* Die Abstandhalter zentrieren die Abgasleitungsabschnitte ab dem Mindestabstand von 20 mm und sind ggf. anzupassen.									

Alle Maße in mm		Muffe Ø	DN	60	80	100	110	125	160	200	250
		Durchmesser außen	D	60	80	100	110	125	160	200	250
		Durchmesser innen	Di	56	76	96	105	119	153	193	242
		Muffenaußenmaß	MA	75	94	115	128	146	184	220	274
<b>87°-Kontroll-Bogen</b>			E	97	161	172	139	134	180	234	230
			M	36	87	97	78	69	84	188	134
			NL	99	166	177	143	138	184	243	237
<b>Kontroll-Rohr</b>			NL	147	190	210	230	215	261	366	434
			K	104	132	142	147	149	190	209	265
<b>30°-Bogen</b>			E	79	125	107	85	90	125	273	144
			M	17	50	26	23	25	28	82	48
			NLV	177	323	245	199	212	285	662	355
			V	47	86	65	53	56	76	177	95
			NL	94	168	130	105	112	149	344	185
<b>45°-Bogen</b>			E	81	125	125	94	99	137	283	162
			M	22	50	50	32	35	40	78	66
			NLV	174	296	296	213	226	302	616	387
			V	71	121	121	87	92	125	254	160
			NL	96	160	160	117	124	165	338	208
<b>87°-Bogen</b>			E	101	162	172	139	134	180	230	230
			M	39	87	96	79	69	84	189	134
			NLV	147	261	282	229	213	278	442	383
			V	138	244	264	216	199	263	420	362
			NL	103	166	177	143	138	184	240	237
<b>Kondensatablauf, mit Siphon</b>			NL	137	137	137	137	161	131	199	395
			K	98	98	97	97	110	111	173	331

## Stark in Qualität und Service

Im ständigen Dialog mit erfahrenen Partnern nutzen wir die Chance und entwickeln Ideen und Produkte, die den Kunden einen zusätzlichen Nutzen bieten.

Service - egal ob in der Beratung oder Berechnung - wird bei uns groß geschrieben.

- Planungs- und Montagehinweise für viele Bereiche und Einzelprodukte
- Detailinfos zu den Artikeln - einfach Artikelnummer unter „Produkte“ eingeben
- Maßzeichnungen für zahlreiche Produkte und Artikel. Es werden immer mehr!
- Planungsformular zur Berechnung des Querschnitts und zur PDF-Formulare zur Planung von Schalldämpfern und Wärmepumpen
- Seminarkalender:  
Unsere Weiterbildungsangebote mit vielen Tipps und Tricks



[atec-abgas.de/produkte/](http://atec-abgas.de/produkte/)



[atec-abgas.de/planung/](http://atec-abgas.de/planung/)



[seminare.atec-abgas.de](http://seminare.atec-abgas.de)

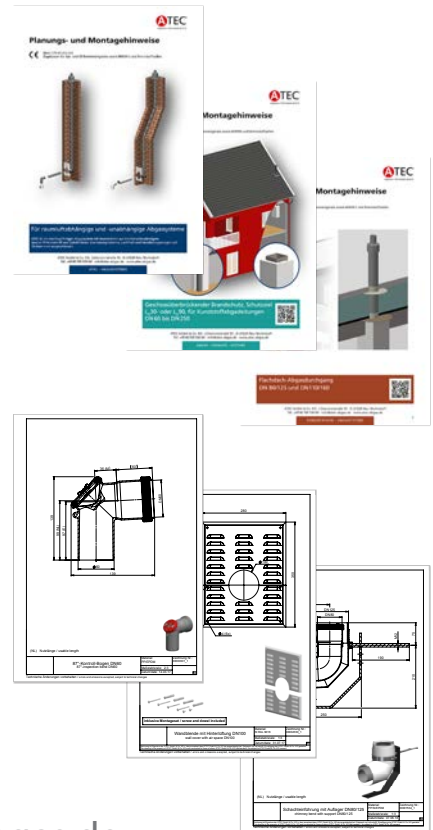

Entdecken Sie unsere Webseite unter [www.atec-abgas.de](http://www.atec-abgas.de)

