



SERIES VTD500



NO.1 IN HYDRONIC SYSTEM CONTROL

Mtrl.n: 9814.04.77 • Rit.n: 9237 • utg. C • Rev. 1604



Series VTD580

CE
PED 2014/68/EU, article 4.3

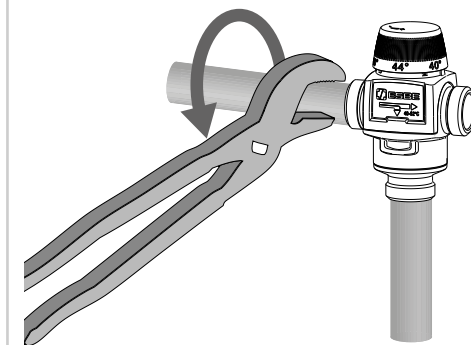
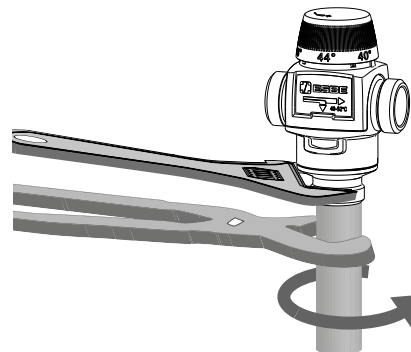
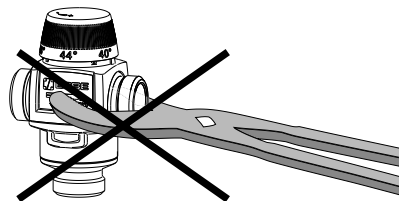
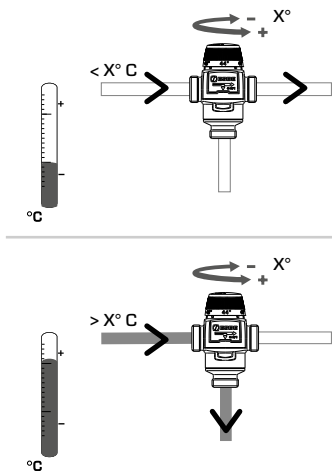
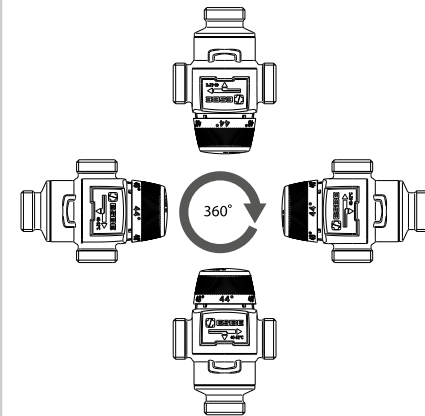
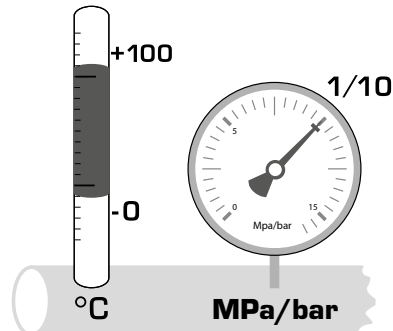

2

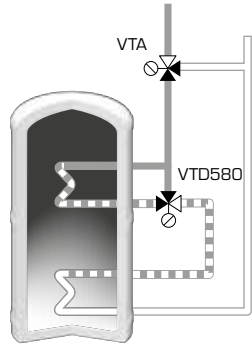

3

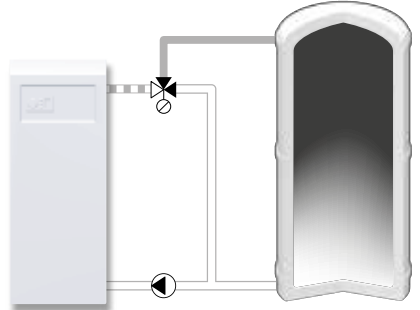

4

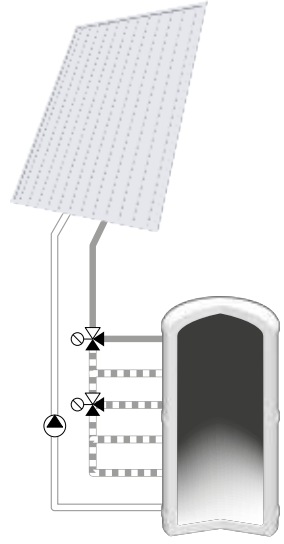

5

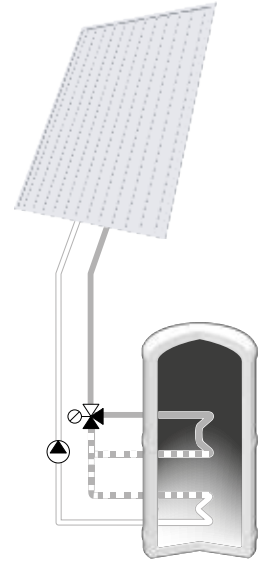

All piping Schematics are General Representations

i

VTD580

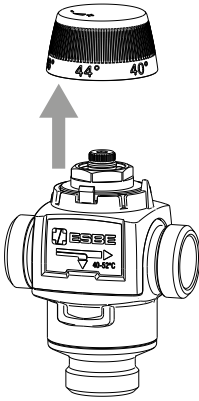

VTD958

