



Art. 6635 / 1/2" (ohne Kragen)

Art. 6610 / 1/2" (mit Kragen)

Art. 6615 / 3/4" (mit Kragen)

Mauer Variante

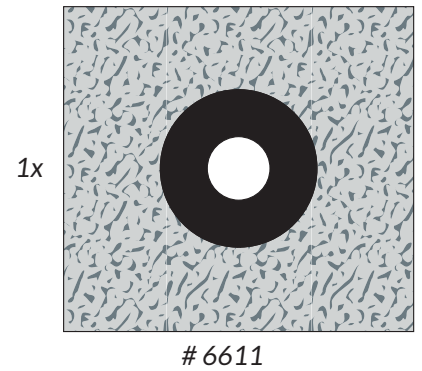
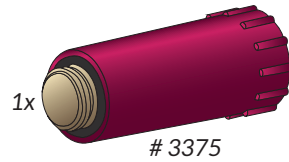
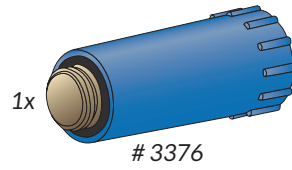
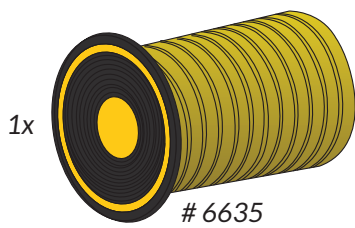

Nach DIN 18534-1

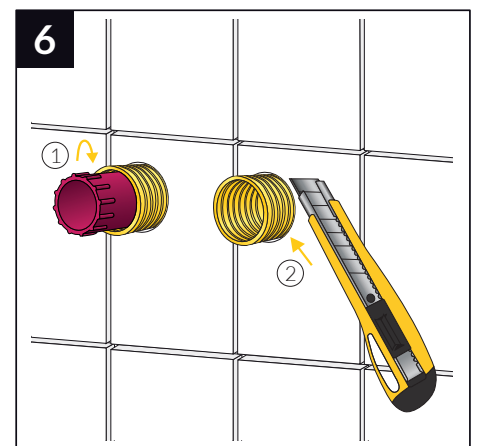
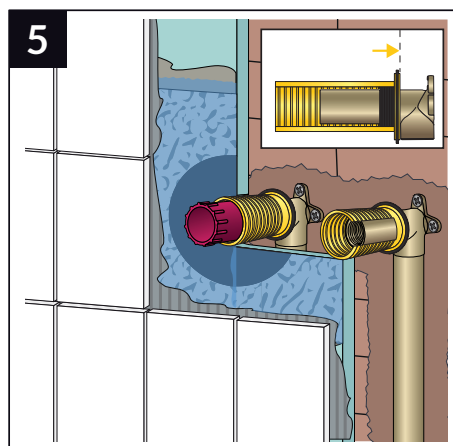
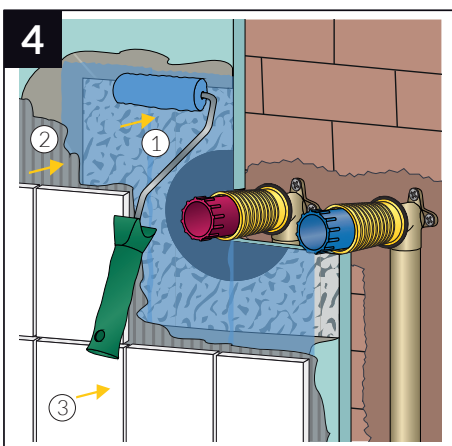
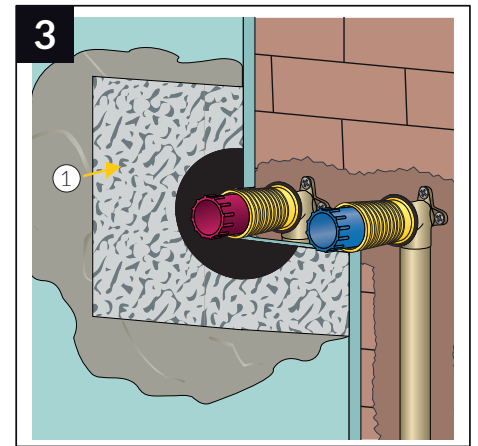
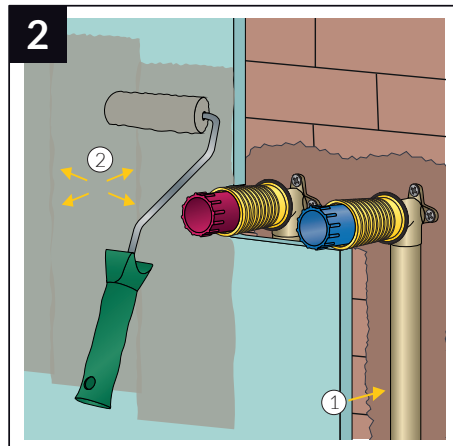
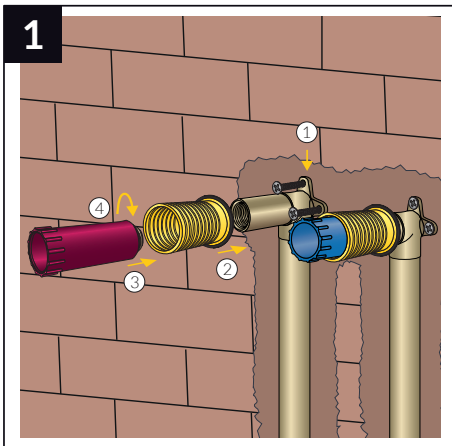



Trockenbau Variante

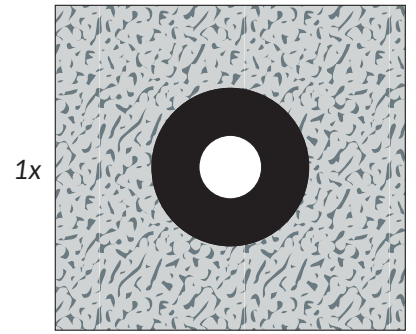
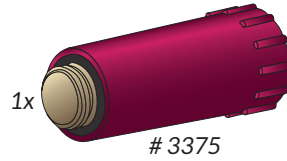
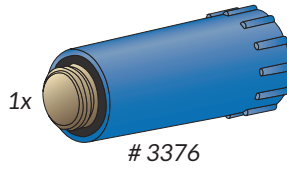
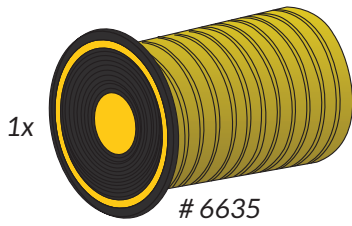

Nach DIN 18534-1

