

Side view

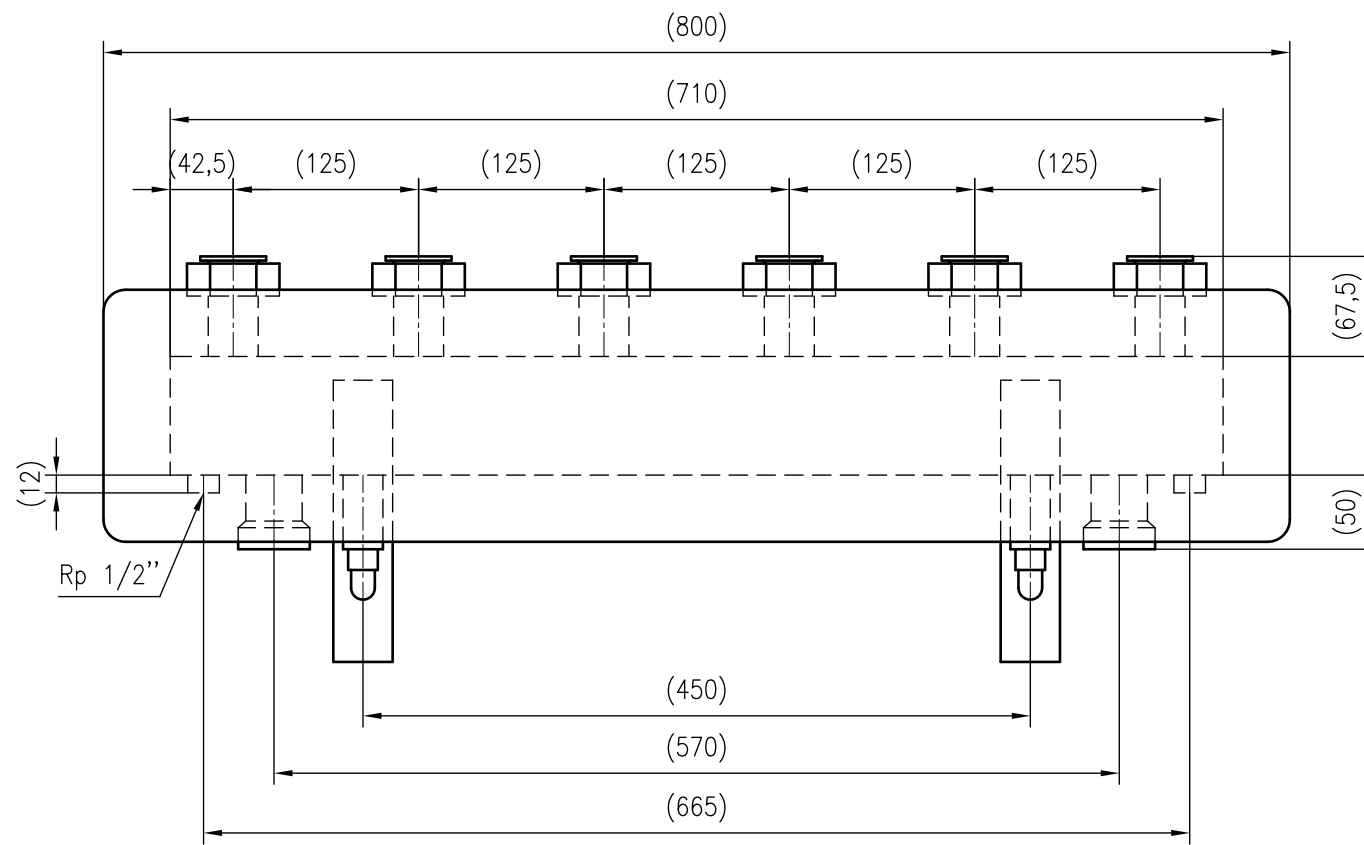

Front view

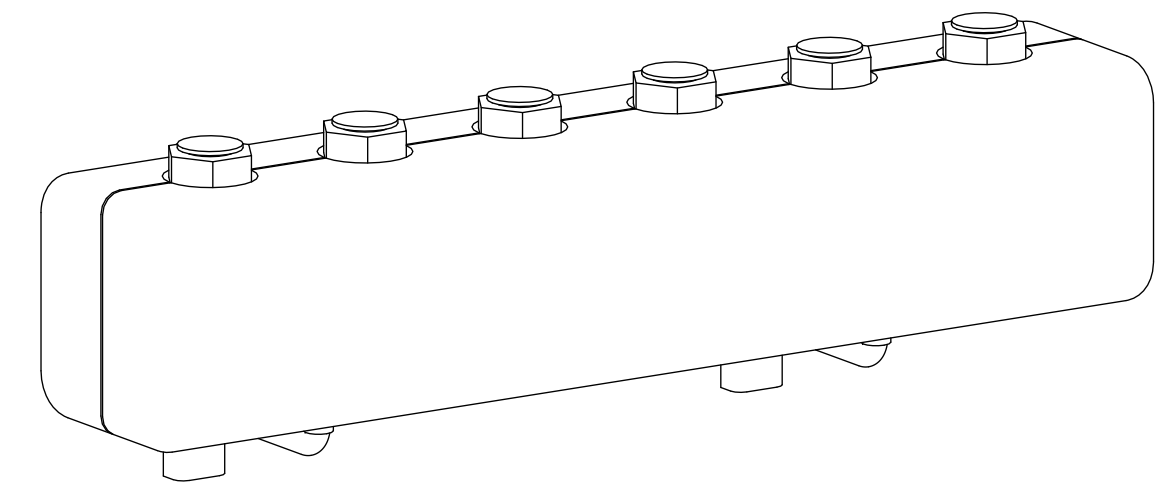

Isometric view

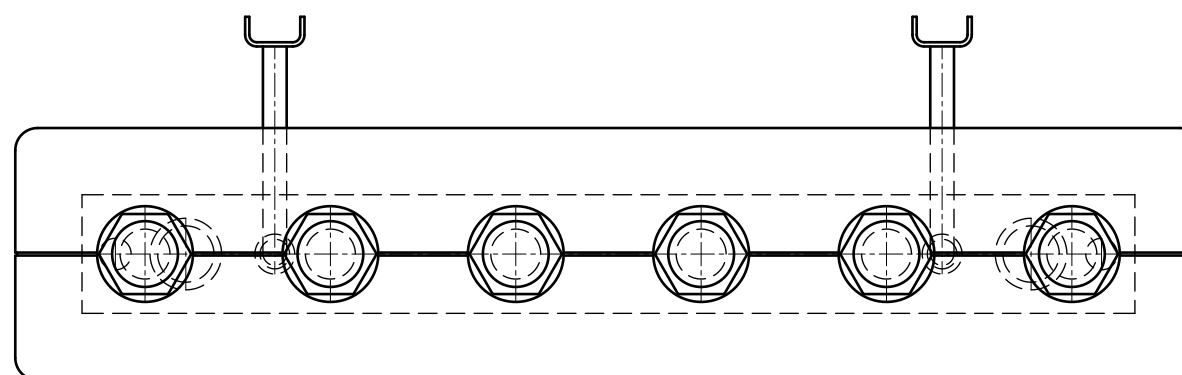

Top view



Unterliegt nicht dem Änderungsdienst/ Not subject to change management		Maßstab/ Scale: 1:5	Format/ Size: A2
Revision 18.08.2021	HydroFixx Set 80x80 3HK kpl, 4208061		