 TS: 4 - 45 °C
 PS: 8 bar

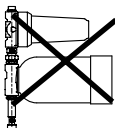

8133111 Pleno Refill Cartridge Filter

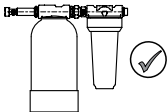
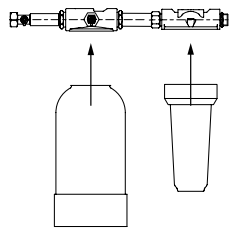
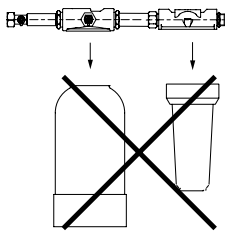
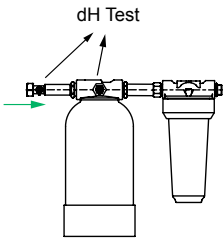
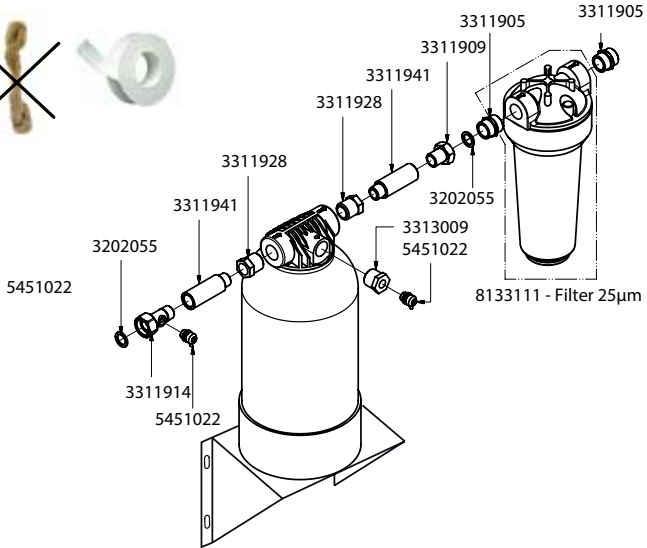

- Optional
 8133211 Refill 16000 Cartridge
 8133221 Refill 36000 Cartridge
 8133231 Refill 48000 Cartridge
 8133261 Refill Demin 13500 Cartridge
 8133271 Refill Demin 18000 Cartridge

Pleno Refill Demin

Water hardness		Demin max I	Demin max I
°dH	ppm CaCO ₃	Refill 13500	Refill 18000
4	70	3375	4500
6	106	2250	3000
8	142	1688	2250
10	178	1350	1800
12	214	1125	1500
14	249	964	1286
16	285	844	1125
18	320	750	1000
20	356	675	900
22	392	614	818
24	427	563	750
26	463	519	692
28	498	482	643
30	534	450	600
32	570	422	563
34	605	397	529
36	641	375	500

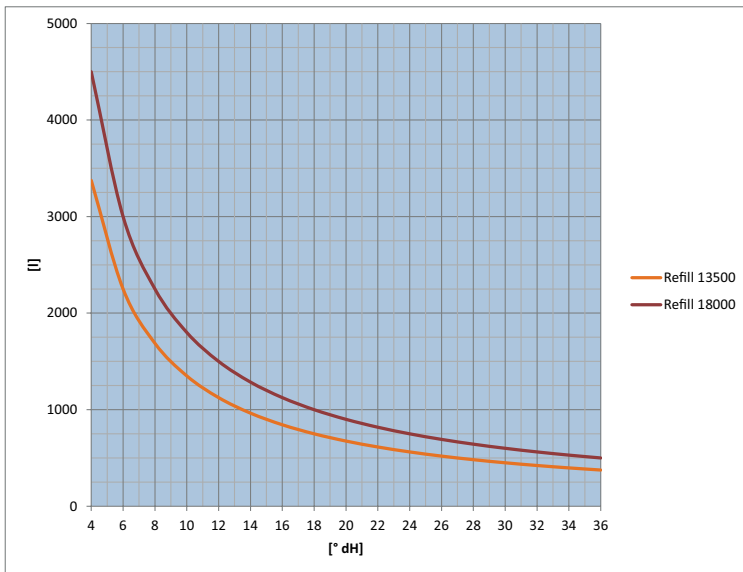

Pleno Refill

Water hardness	°dH	ppm CaCO ₂	≤ 16.8 °dH max I			≤ 11.2 °dH max I			≤ 8.4 °dH max I			≤ 0.11 °dH max I		
			Refill 16000	Refill 36000	Refill 48000	Refill 16000	Refill 36000	Refill 48000	Refill 16000	Refill 36000	Refill 48000	Refill 16000	Refill 36000	Refill 48000
10	178					20000	45000	60000	10000	22500	30000	1618	3640	4853
12	214					5714	12857	17143	4444	10000	13333	1346	3028	4037
14	249					3333	7500	10000	2857	6429	8571	1152	2592	3456
16	285					2353	5294	7059	2105	4737	6316	1007	2266	3021
18	320	13333	30000	40000		1818	4091	5455	1667	3750	5000	894	2012	2683
20	356	5000	11250	15000		1481	3333	4444	1379	3103	4138	804	1810	2413
22	392	3077	6923	9231		1250	2813	3750	1026	2308	3077	731	1645	2193
24	427	2222	5000	6667		1081	2432	3243	909	2045	2727	618	1390	1854
26	463	1739	3913	5217		952	2143	2857	816	1837	2449	574	1291	1721
28	498	1429	3214	4286		851	1915	2553	741	1667	2222	535	1204	1606
30	534	1212	2727	3636		769	1731	2308	678	1525	2034	502	1129	1505
32	570	1053	2368	3158		702	1579	2105	625	1406	1875	472	1062	1416
34	605	930	2093	2791		645	1452	1935	580	1304	1739	446	1003	1337
36	641	833	1875	2500										

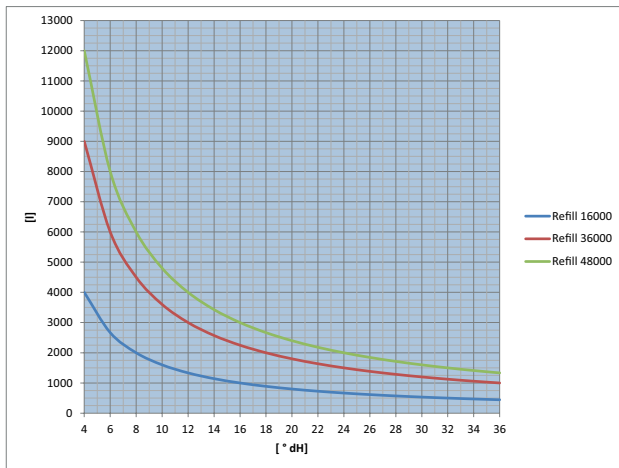

Pleno P BA4 + Pleno Refill

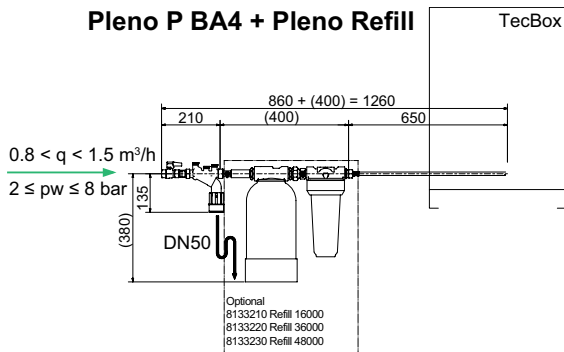

www.imi-hydronic.com

We reserve the right to introduce technical alterations without previous notice.