

Edition 11

31198890001 Waschtischunterbau

PRODUKT



ZEICHNUNG

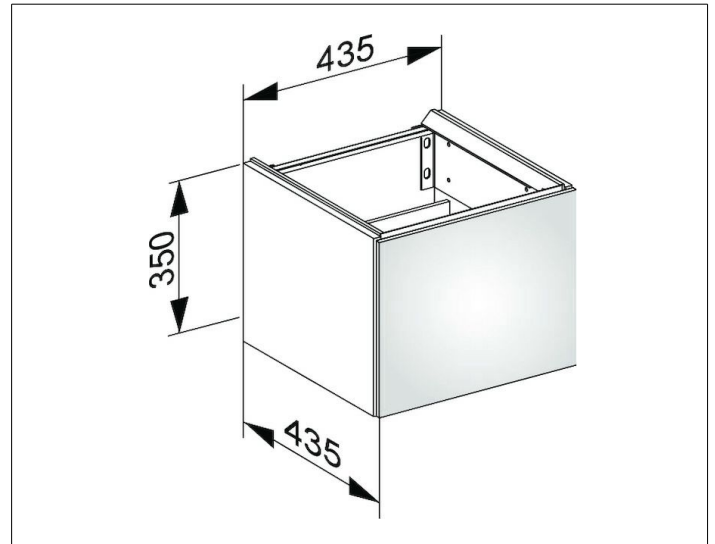

OBERFLÄCHE

Eiche-hell Furnier/Eiche-hell Furnier

ABMESSUNG

435 x 350 x 435 mm