

Side view

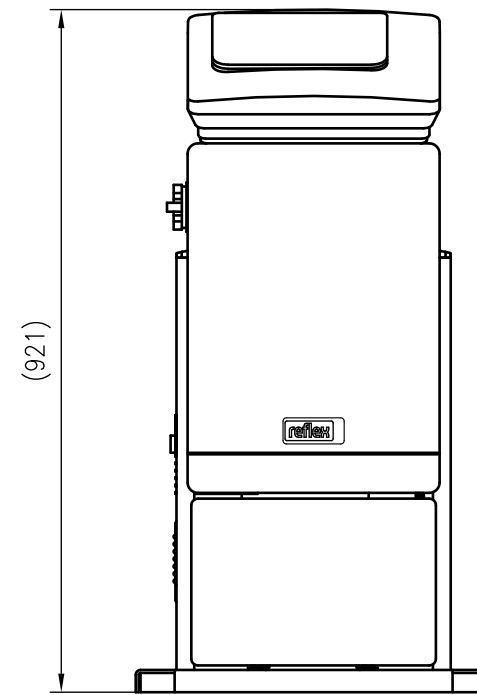

Front view

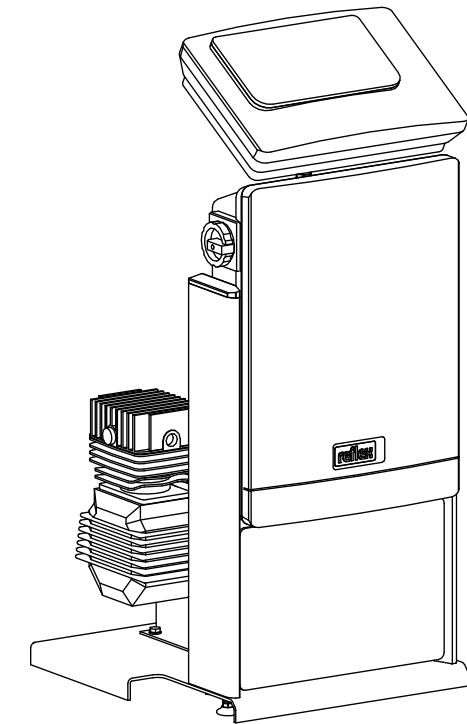

Isometric view

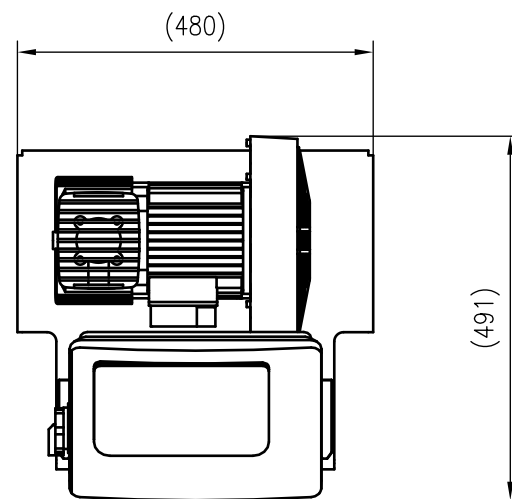

Top view



Unterliegt nicht dem Änderungsdienst/ Not subject to change management		Maßstab/ Scale: 1:10	Format/ Size: A3
Revision 01.04.2016	Reflexomat RS150 1 – 8880311		

1

2

3

4

5

6

7

A3

A

B

C

D

E

F

A

B

C

D

E

F