

1150011265
3113842

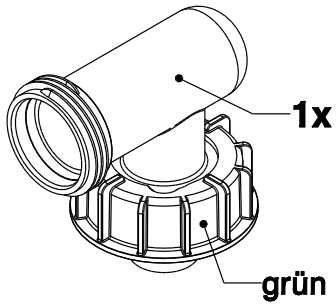

1x
**Kompl.
Beutel**

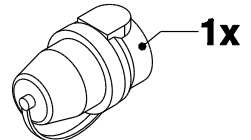
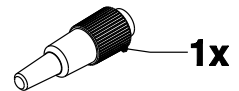
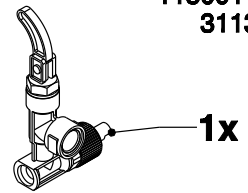
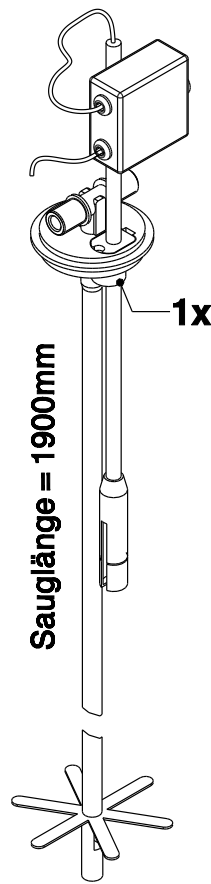
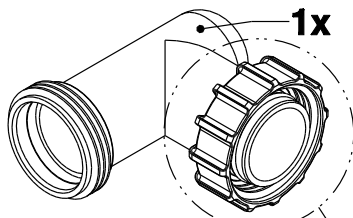
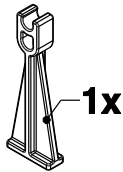

je 1x
Beschreibung und Konformität
Heft 1 (GWG)

Montage- und Betriebsanleitung
Heft 2 (GWG)

Universal-Anschlussarmatur
UA 6, 8 und 10 mm
in separatem Beutel

1x
**Kompl.
Beutel**

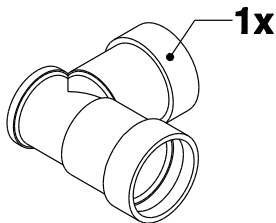
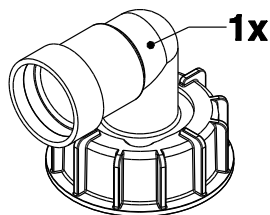

| | | | |
|---------|---|----|----|
| | 2x | | 2x |
| 3113916 | Übersichtszettel Beutelinhalt Grundeinheit G DWT 750 / 1000 Füllstar | 1x | |
| 3113461 | Montageanleitung DWT alle Typen, DE | 1x | |
| 3112139 | Zulassungsheft A5 Füllstar Z-40.7-487 | 1x | |
| 3112140 | Aufkleber (2 Stück) Zulassung Füllstar Düse 6 mm | 1x | |

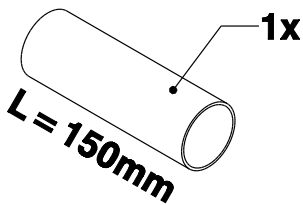

Kontrollmarke (Seriennummer,
Hersteldatum, Prüfer)

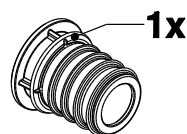
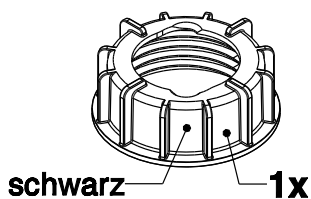

XXXXXXXXXX

TT.MM.JJJJ

XXX