

Thermostatic mixing valve, adjustable with knob and with anti-scald function

5217 series



BSI EN ISO 9001:2000
Cert. n° FM 21654



UNI EN ISO 9001:2000
Cert. n° 0003



Function

In some hot water distribution systems there is a need to protect the most vulnerable people against scalding caused by hot water, such as, for example, in hospitals, in nursing homes or in schools.

This particular series of thermostatic mixing valves has been specially designed for these applications and installation upstream the point of use.

These thermostatic mixing valves ensure high thermal performance. They are able to accurately control the temperature of the mixed water supplied to the user in case of variations in the inlet supply pressure or temperature, or in the flow rate.

They are designed with a special anti-scald function which immediately shuts off the flow of water discharging from the mixed water outlet in the event of a failure of cold supply. (Certified under standard NF 079 doc. 8 - Device of class 12 (1/2") and class 20 (3/4"), RU type, regulated by user).



Product range

- Code **521714** Thermostatic mixing valve, adjustable with knob and with anti-scald function, complete with strainers and check valves at the inlet _____ Size 1/2"
- Code **521713** Thermostatic mixing valve, adjustable with knob and with anti-scald function, complete with strainers and check valves at the inlet _____ Size 3/4"

Technical specifications

Materials

- Body: dezincification resistant alloy **CR** EN 12165 CW602N, chrome plated
- Shutter: PSU
- Springs: stainless steel
- Sealing elements: EPDM
- Knob: ABS

Performance

- Temperature adjustment range: 30–50°C
- Accuracy: ±2°C
- Max. working pressure (static): 10 bar
- Max. working pressure (dynamic): 5 bar
- Max. inlet temperature: 85°C
- Inlet temperature recommended for optimum system performance, avoiding the build-up of limescale (according to NF079 doc. 8) ≤ 65°C
- Max. inlet pressures ratio (H/C or C/H): 2:1
- Min. temperature difference between hot water inlet and mixed outlet, to ensure anti-scald function: 15°C
- Min. flow rate for stable temperature: 4 l/min (1/2")
6 l/min (3/4")
- Acoustic group: I
- Connections: 1/2" and 3/4" M with union

Dimensions

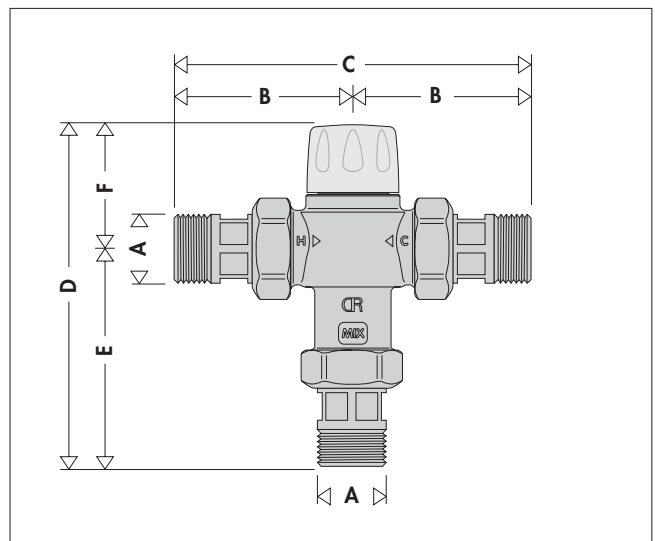

Code	A	B	C	D	E	F	Weight (Kg)
521714	1/2"	62,5	125	126,5	81,5	45	0,58
521713	3/4"	67	134	127	82	45	0,81

Legionella vs scalding risk

In systems producing hot water with storage, in order to avoid the dangerous infection known as Legionella, the hot water must be stored at a temperature of at least 60° C. At this temperature it is certain that the growth of the bacteria causing this infection will be totally eliminated. At this temperature, however, the water cannot be used directly.

As shown in the diagram opposite, temperatures of more than 50°C can cause burning very quickly.

For example, at 55°C, partial burning will occur in approximately 30 seconds, while at 60°C partial burning will occur in approximately 5 seconds.

This time may be reduced by 50% for children and elderly people.

In view of the above, it is necessary to use a thermostatic mixing valve which can:

- reduce the temperature at the point of use to a value lower than that of the storage and make it suitable for sanitary use.
- maintain the temperature constant while the incoming pressure and temperature conditions vary.
- prevent the water temperature at the outlet from reaching values above 50°C.
- have an anti-scald safety function in case of failure of the cold water supply.

Temperature - Exposure time

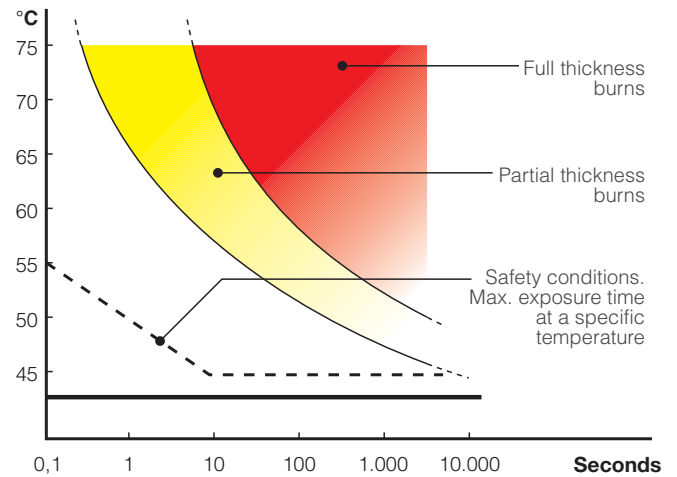

Thermal disinfection

The drawing alongside shows the behaviour of *Legionella Pneumophila* bacteria as the conditions vary in the temperature of the water containing the bacteria. To ensure correct thermal disinfection, it is necessary to go up to values of no less than 60°C.

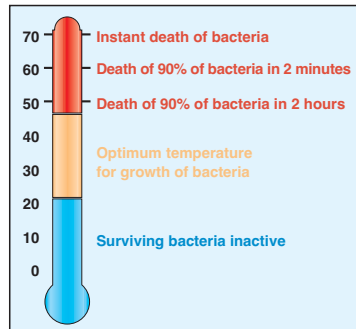

Exposure time required to cause partial burns

Temperature	Adults	Children 0-5 years
70°C	1 s	—
65°C	2 s	0.5 s
60°C	5 s	1 s
55°C	30 s	10 s
50°C	5 min	2,5 min

Operating principle

The thermostatic mixing valve mixes the hot and cold water at the inlet so as to maintain the mixed water at a constant set temperature at the outlet. A thermostatic element is fully immersed in the mixed water pipe. It contracts or expands, thus moving an obturator which controls the hot or cold water passage at the inlet. If there are changes in inlet temperature or pressure, the internal element reacts automatically to restore the set temperature at the outlet.

Construction details

Anti-scale materials

The materials used in constructing the mixing valve were selected to eliminate seizing due to limescale deposits. All functional parts have been made using a special material with low friction coefficient, which ensures over time performance.

Anti-scald safety function

As a safety measure, in case of failure of the cold water supply, the valve immediately shuts off the flow of mixed water. This prevents dangerous burns.

This performance is guaranteed if there is a minimum temperature difference between the inlet hot water and the outlet mixed water of 15°C (performance in compliance with French standards NF 079 Doc. 8).

In case of failure of the hot water supply, the valve shuts off the mixed water to prevent dangerous thermal shocks.

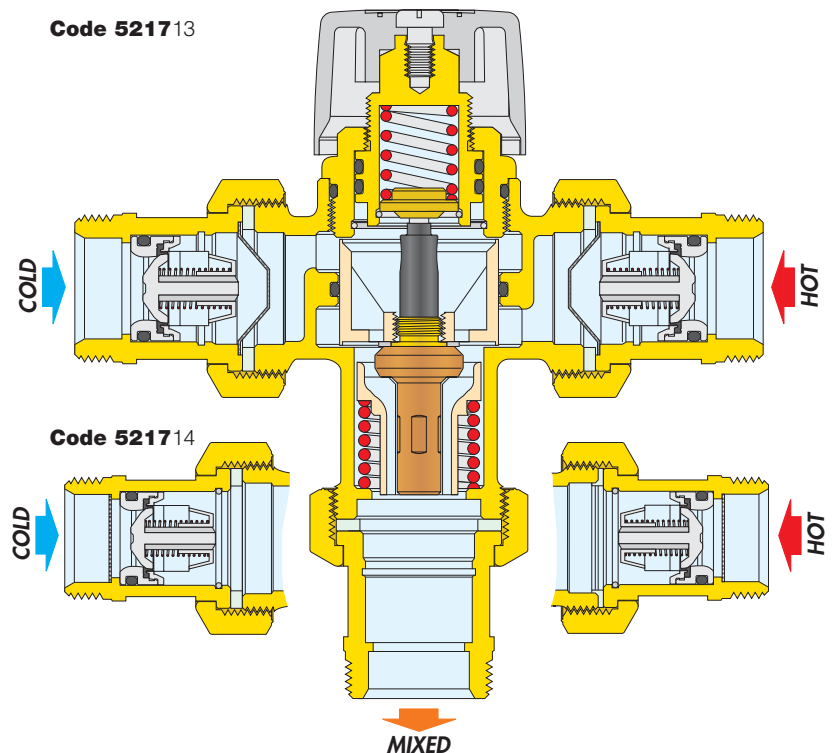

Hydraulic characteristics

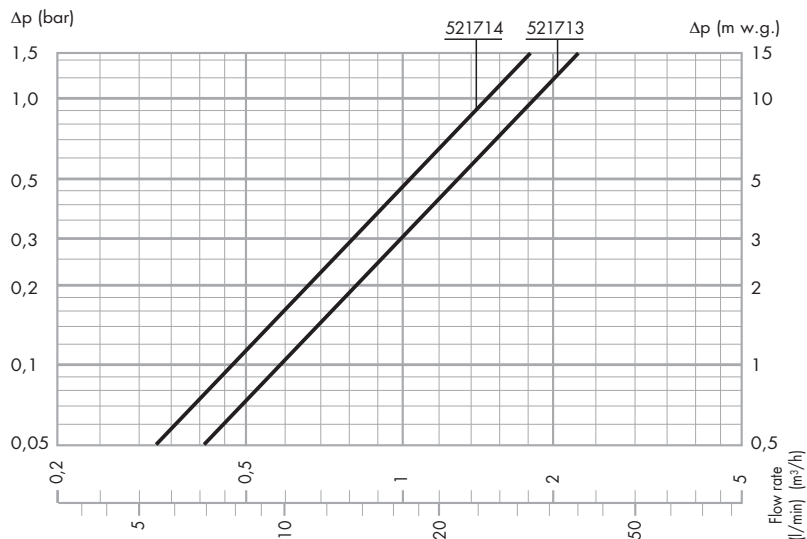

Code	Ø	Kv (m³/h)
521714	1/2"	1,5
521713	3/4"	1,85

Use

According to its flow characteristics, the Caleffi 5217 series thermostatic mixing valves can be used for application at the point of use or for a limited number of users, for example a bathroom. For this reason, the flow passing through the valve is generally the same as through the final user, for example the tap of a basin, shower, bidet, etc. To ensure a stable operation, a minimum flow rate of 4 l/min (1/2") and 6 l/min (3/4") must be guaranteed to the mixing valve. The system must always be sized taking into account the current legislation on the nominal flow rate to each user.

Public buildings, hospitals, nursery schools

In this type of application the risk of scalding is extremely high because of the nature of the hot water users, who include children, old people, sick people. In these installations, the two supply networks providing hot water from the boiler and cold water may have different origins and operate at different pressures. In case of failure of the cold water supply, the mixing valve is able to shut off the supply of mixed water to prevent possible scalding.

Selecting the correct size mixing valve

If the design flow rate is known, taking into account simultaneous use of the sanitary appliances, the dimensions of the mixing valve are chosen by checking the graph provided to find the loss of head produced. In this case, it is necessary to check the available pressure, the loss of head in the system downstream of the mixer and the residual pressure to be guaranteed to user appliances.

Installation

Before installing the mixing valve, the connecting pipes should be washed to remove any impurities that could impair performance.

We always recommend installing strainers of sufficient capacity at the inlet from the public water network.

The 5217 series mixing valves are equipped with strainers on the hot and cold water inlets.

The 5217 series thermostatic mixing valves must be installed as shown in the installation diagrams on the instruction sheet or in this leaflet.

The 5217 series thermostatic mixing can be installed in any position, horizontally or vertically.

The following marks are indicated on the mixing valve body:

- hot water inlet, indicated by the letter "H" (Hot)
- cold water inlet, indicated by the letter "C" (Cold)
- mixed water outlet, indicated by the word "MIX".

Check valves

In systems with thermostatic mixing valves, check valves should be installed to prevent undesired flow return. 5217 series mixing valves are equipped with check valves at the hot and cold water inlets.

Thermal transient

During transient, following rapid changes in pressure, temperature or flow rate, the temperature increases with respect to the initial set point and this increase must be of limited duration to guarantee safety.

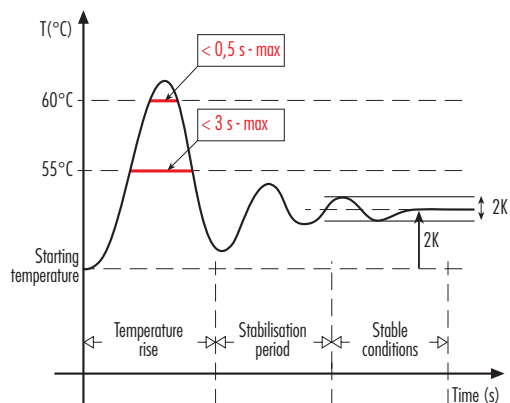

Commissioning

In view of the special purpose of the thermostatic mixing valve, it must be commissioned in accordance with current regulations by qualified personnel using appropriate temperature measurement equipment. Use of a digital thermometer is recommended for measuring the temperature of the mixed water.

Temperature setting

The temperature is set at the desired value using the regulator knob. Given the particular use of this type of mixing valve, the following table shows the recommended maximum outlet water temperatures to prevent scalding.

Appliance	Tmax.
Bidet	38°C
Shower	41°C
Wash basin	41°C
Bath tub	44°C

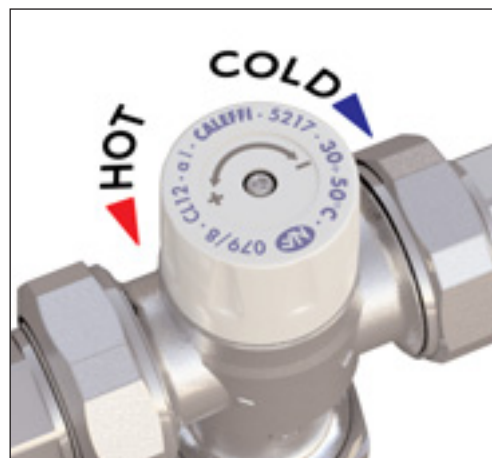

Application diagrams

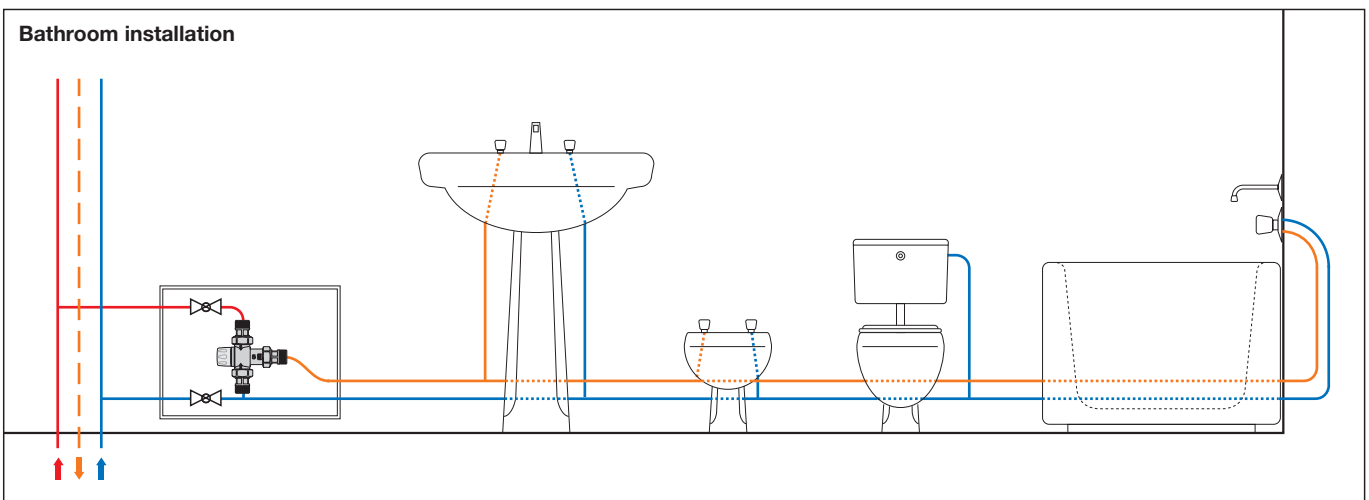
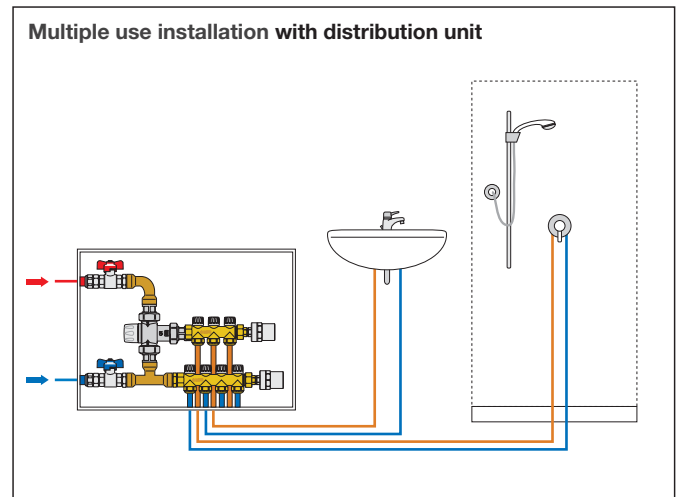
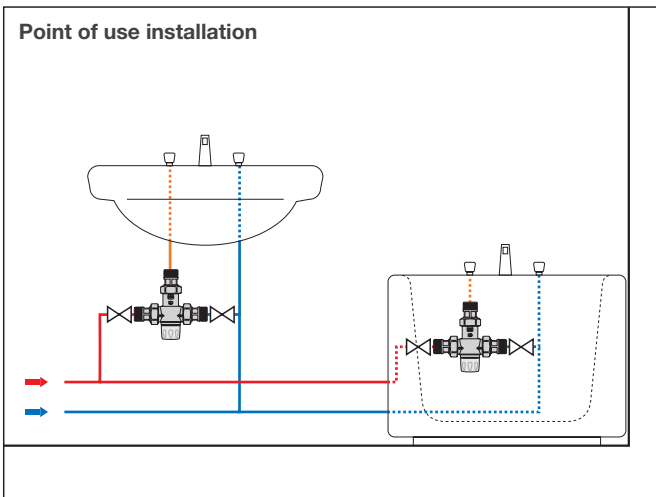

SPECIFICATION SUMMARIES

5217 series

Thermostatic mixing valve adjustable with knob and with anti-scald function. Certified under standard NF 079 doc. 8. 1/2" and 3/4" M connections. Dezincification resistant alloy body. Chrome plated. Shutter in PSU. Stainless steel springs. EPDM seal elements. ABS knob. Maximum working temperature 85°C. Adjustment range 30–50°C. Accuracy $\pm 2^\circ\text{C}$. Maximum working pressure (static) 10 bar. Maximum working pressure (dynamic) 5 bar. Maximum inlet pressures ratio (H/C or C/H) 2:1. Complete with strainers and check valves at the inlets.

We reserve the right to change our products and their relevant technical data, contained in this publication, at any time and without prior notice.



CALEFFI S.P.A. · I · 28010 FONTANETOD'AGOGNA (NO) · S.R. 229, N.25 · TEL. +39 0322 8491 R.A. · FAX +39 0322 863723·

www.caleffi.com · info@caleffi.com ·

© Copyright 2007 Caleffi S.P.A.