

TVC00046200061

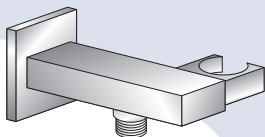

TVC00046300061

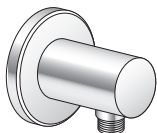

TVC00045600061

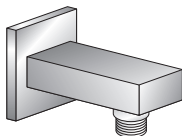

TVC00045700061

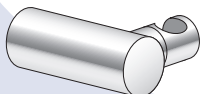

TVC00045800061

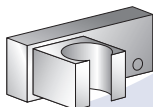

TVC00045900061

WALL BRACKETS  
WALL ELBOWS  
WALL HAND SHOWER HOLDER

- D** Montageanleitung
- GB** Installation instructions
- FR** Instructions de montage
- CN** 安装说明书
- ES** Instrucciones de instalación

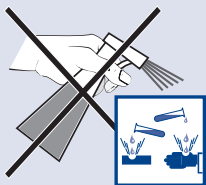

TVC00046200061

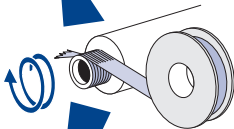
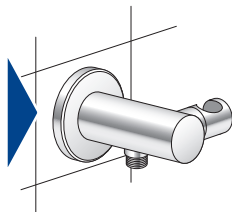
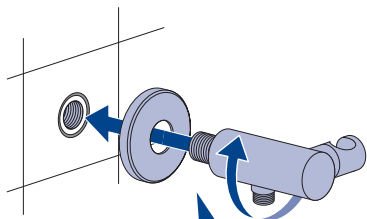

TVC00045600061

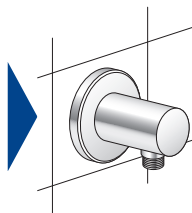
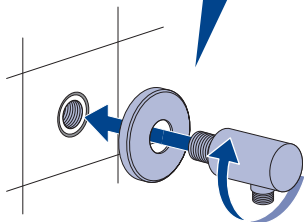

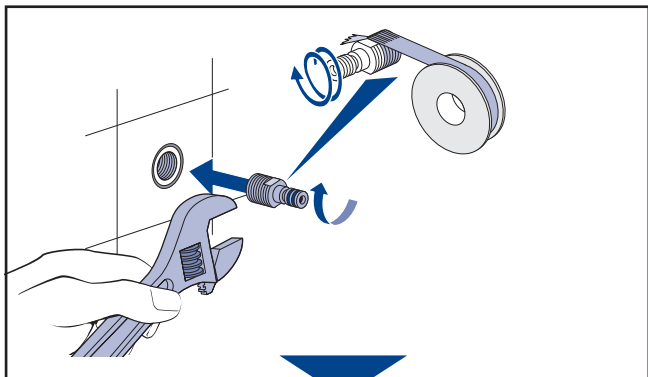

TVC00046300061

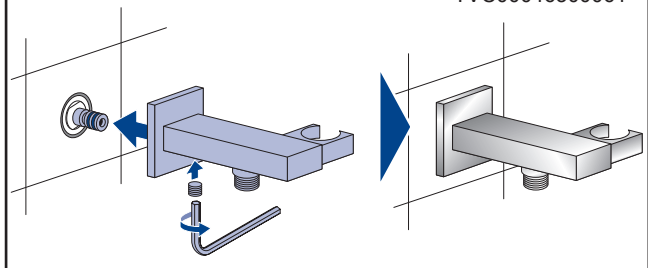

TVC00045700061

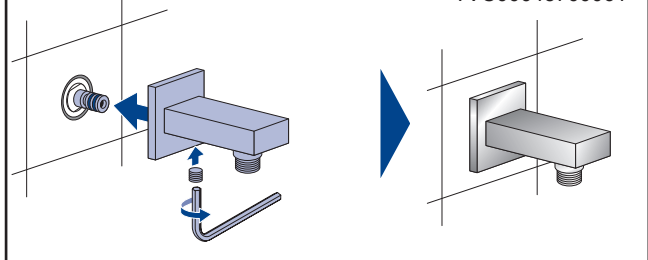

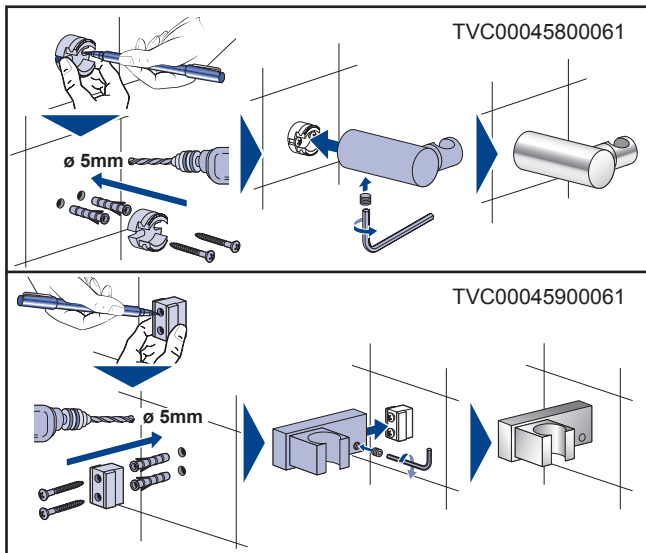

Controlled

Änderungen vorbehalten  
We reserve the right to make alterations  
Sous réserve de modifications  
我们保留作出改变的权利  
Nos reservamos el derecho de hacer  
cambios o modificaciones

Villeroy & Boch Service centre  
Tel: 400-820-1748

  
**Villeroy & Boch**  
1748

Villeroy & Boch AG  
Postfach 12 30 - 66689 Mettlach  
Germany  
Tel: +49 (0) 6864 816000  
Fax: +49 (0) 6864 815687  
[www.villeroy-boch.com](http://www.villeroy-boch.com)

TVM00001001000-V28-2015