

0428 0100

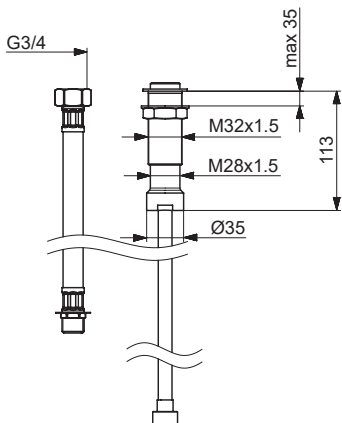

0409 9140

50 - 500 kPa
 0.23 l/s (300 kPa)
 0.25 l/s (300 kPa w/Controller)
 max. +65°C

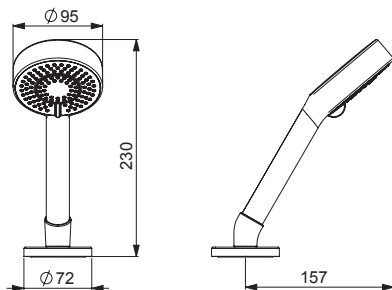

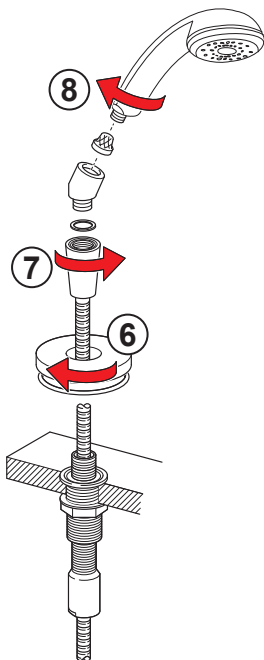
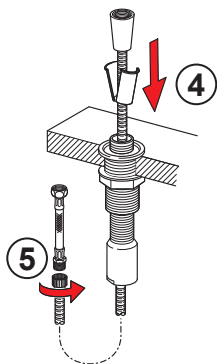
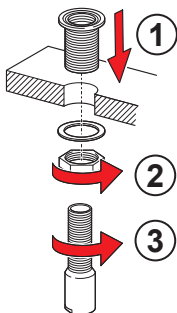
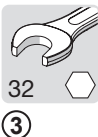
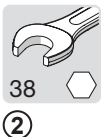
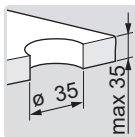

HANSA Armaturen GmbH
P. O. BOX 81 02 40
D-70519 Stuttgart
Sigmaringer Strasse 107
D-70567 Stuttgart

Tel.: +49 711 16 14 0
Fax: +49 711 16 14 368
info@hansa.de
www.hansa.com

943500D-06-22