

# Shower System



- |                                       |                                 |                                 |                                  |
|---------------------------------------|---------------------------------|---------------------------------|----------------------------------|
| <b>DE</b> Montageanleitung            | <b>AR</b> دليل التركيب          | <b>HU</b> Szerelési útmutató    | <b>PT</b> Instruções de montagem |
| <b>EN</b> Installation instructions   | <b>BG</b> Ръководство за монтаж | <b>ID</b> Petunjuk pemasangan   | <b>RO</b> Manual de montaj       |
| <b>ES</b> Instrucciones de montaje    | <b>CS</b> Návod k montáži       | <b>JA</b> 取付説明書                 | <b>SK</b> Návod na montáž        |
| <b>FR</b> Instructions de montage     | <b>DA</b> Monteringsvejledning  | <b>KO</b> 설치 가이드                | <b>SL</b> Navodila za montažo    |
| <b>IT</b> Istruzioni per il montaggio | <b>ET</b> Paigaldusjuhend       | <b>LT</b> Montavimo instrukcija | <b>SV</b> Monteringsanvisning    |
| <b>NL</b> Montagehandleiding          | <b>EL</b> Οδηγίες τοποθέτησης   | <b>LV</b> Montāžas instrukcija  | <b>TH</b> คู่มือการติดตั้ง       |
| <b>RU</b> Инструкция по монтажу       | <b>FI</b> Asennusohje           | <b>NO</b> Monteringsanvisning   | <b>TR</b> Montaj kılavuzu        |
| <b>ZH</b> 安装说明                        | <b>HR</b> Uputa za montažu      | <b>PL</b> Instrukcja montażu    | <b>UK</b> Інструкція з монтажу   |





**i**

✓ 100 kPa (1 bar) - 500 kPa (5 bar)  
⚠ < 1000 kPa (10 bar)

⚠ < 70 °C < 158 °F  
✓ ~ 60 °C ~ 140 °F

~ 10 °C  
~ 50 °F

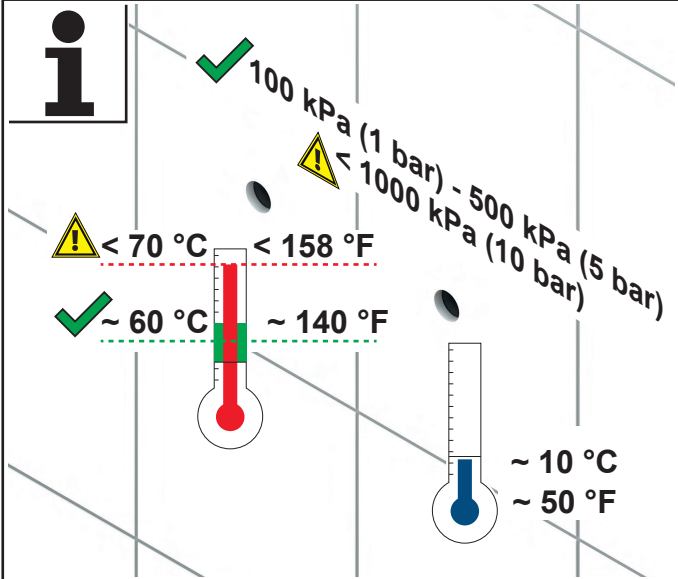

**1**

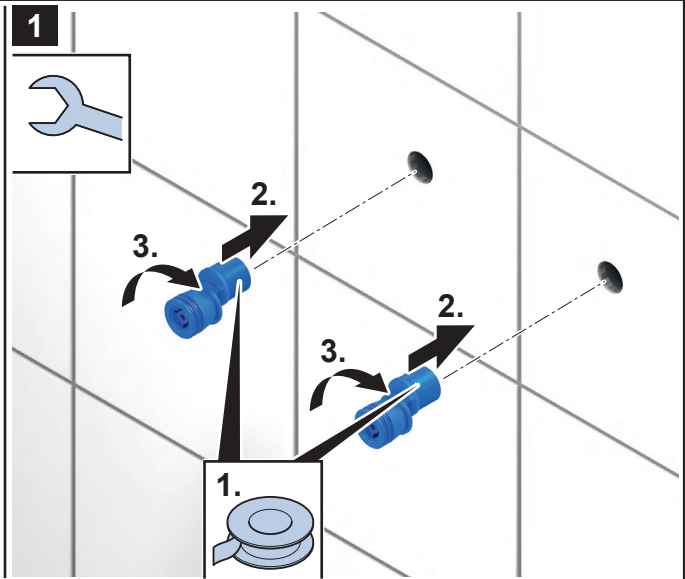

**2**

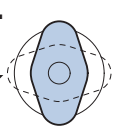
1.  

1 min

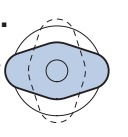
2.  

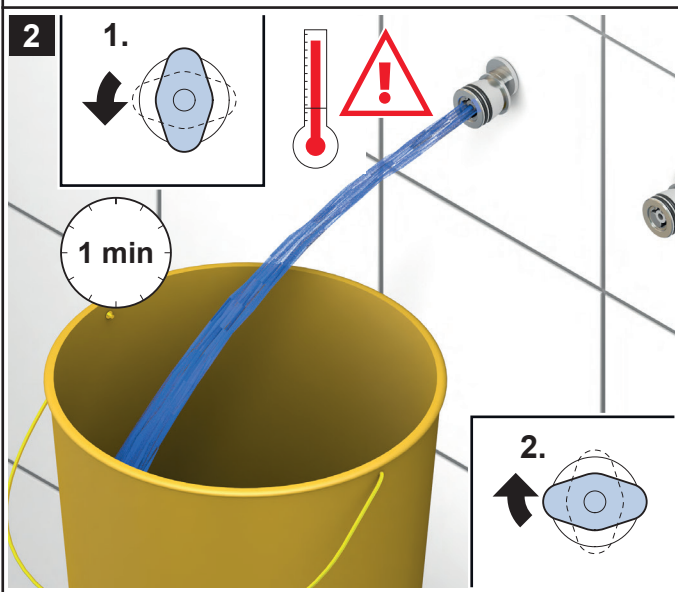

**3**

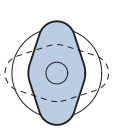
1.  

1 min

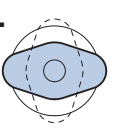
2.  

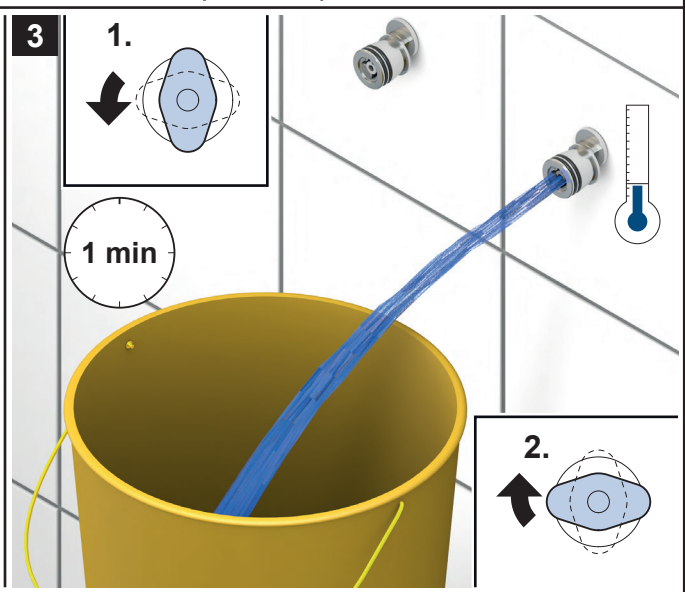

**4a**

	mm	inch
A	150	5 <sup>29</sup> / <sub>32</sub>

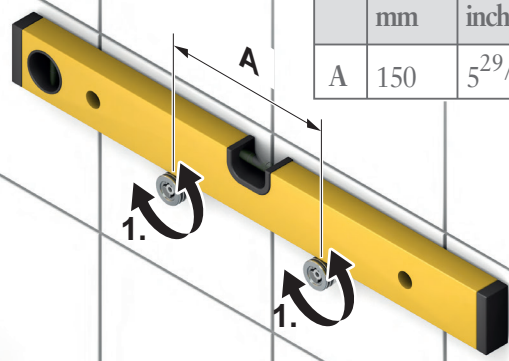
1.  

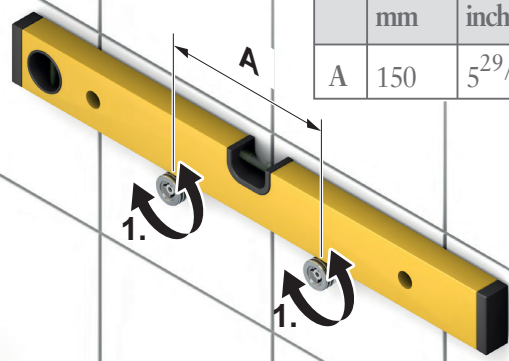
1.  

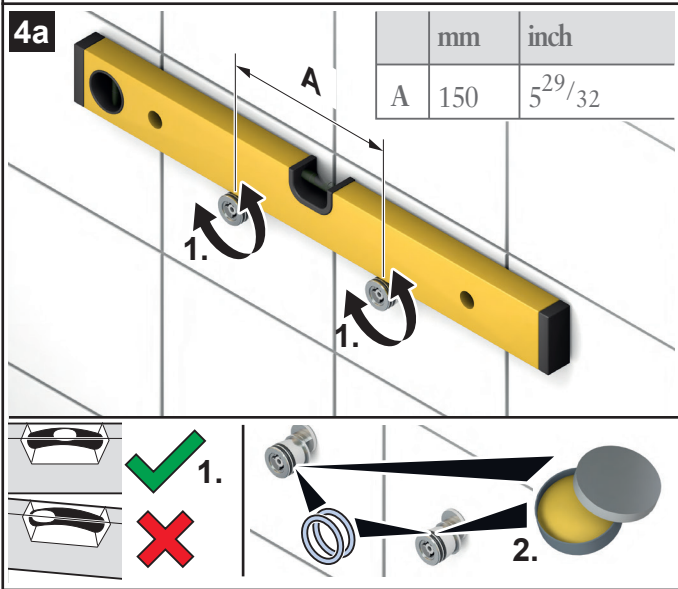

**4b**

	mm	inch
A	150	5 <sup>29</sup> / <sub>32</sub>

A

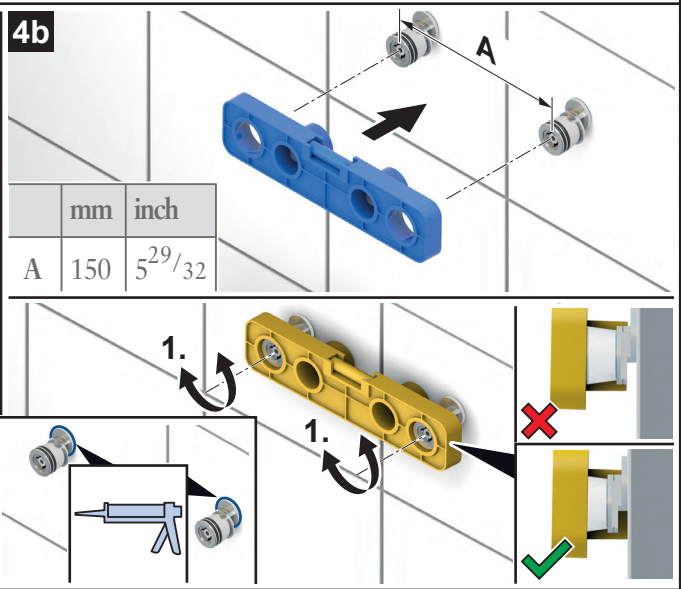
1.  

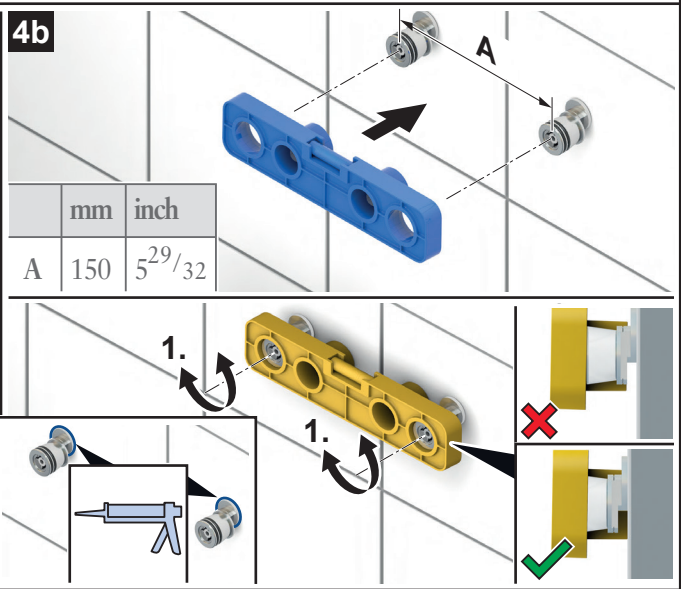
1.  

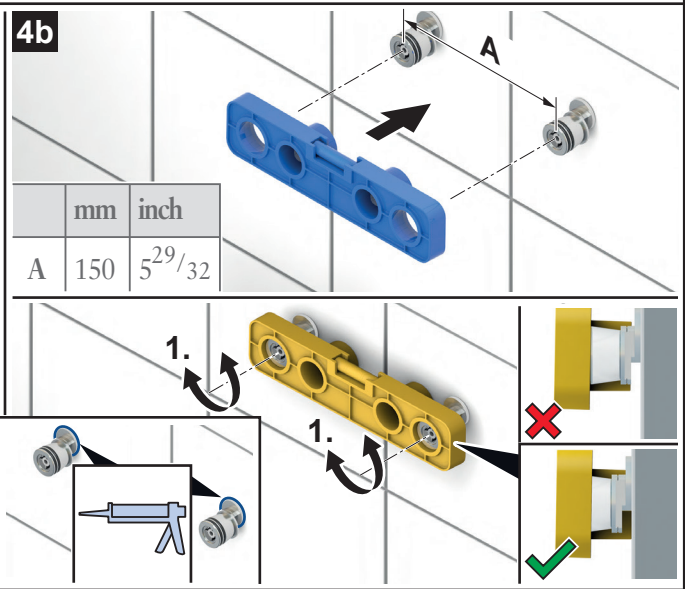

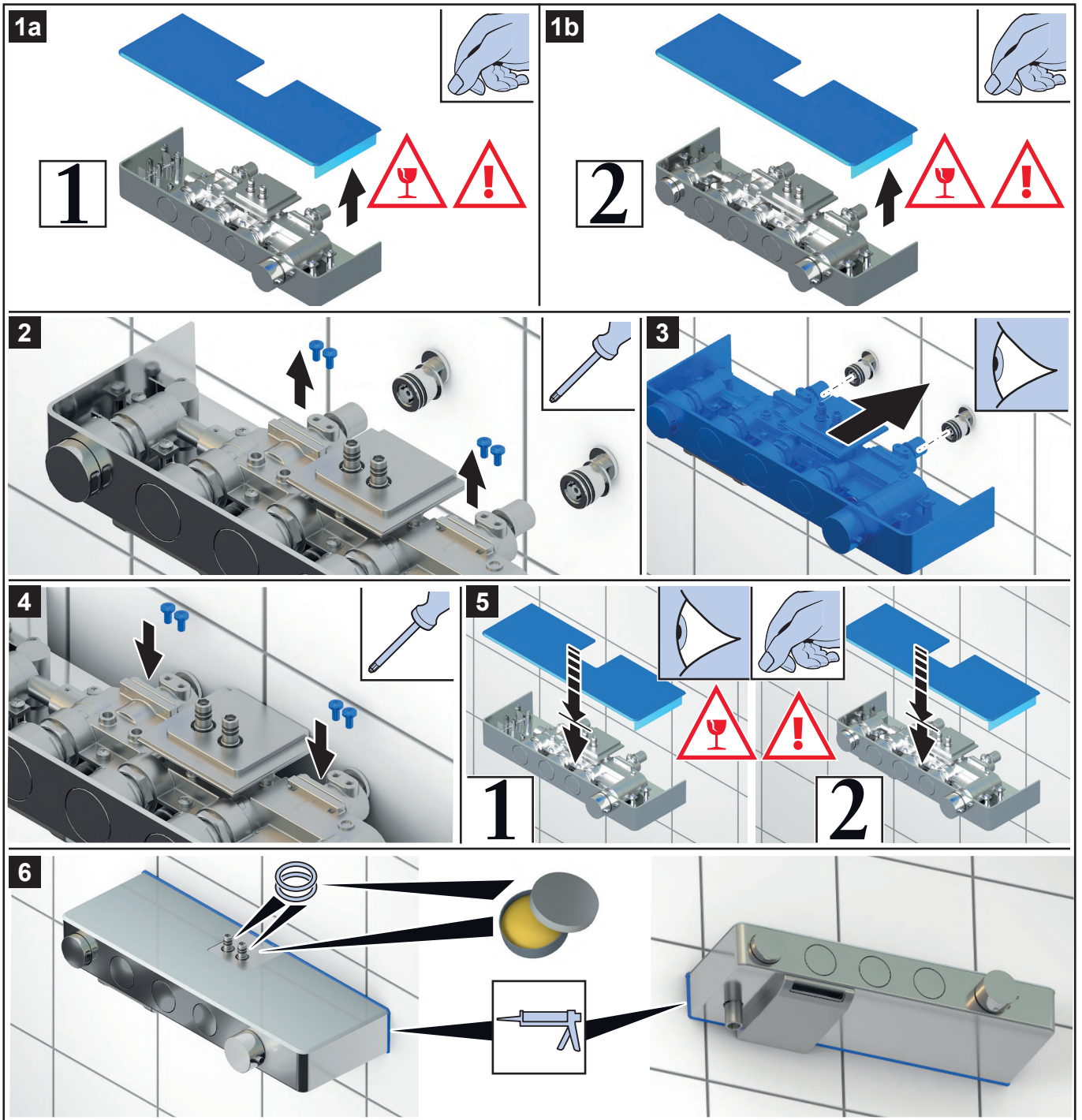

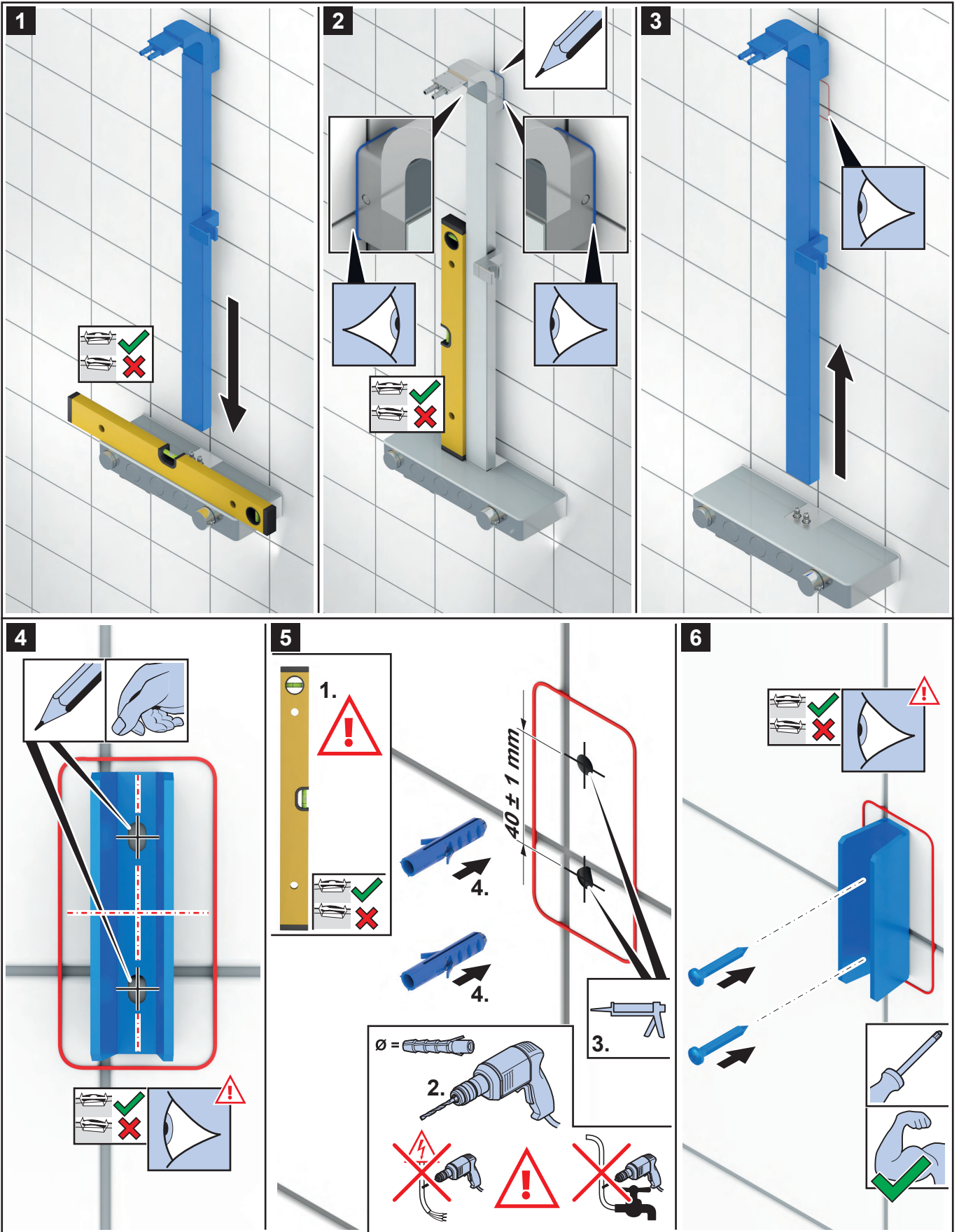

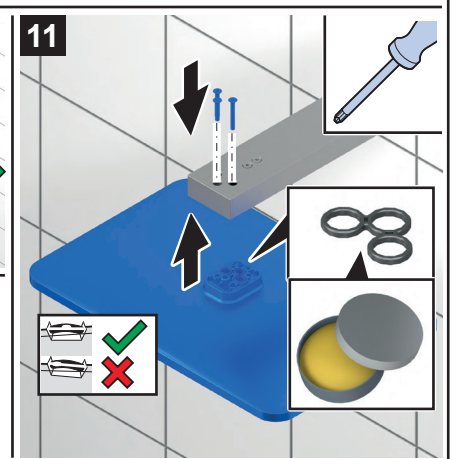
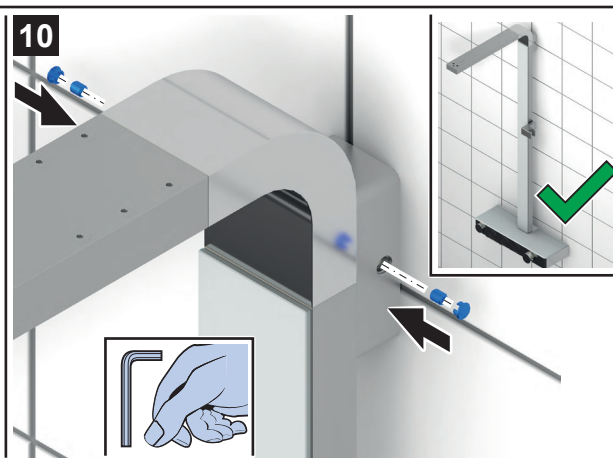
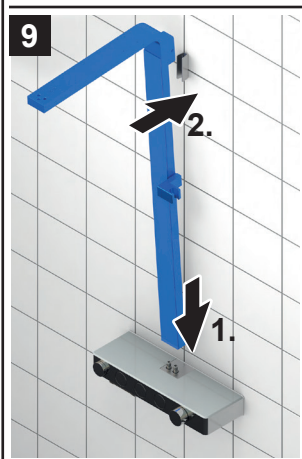
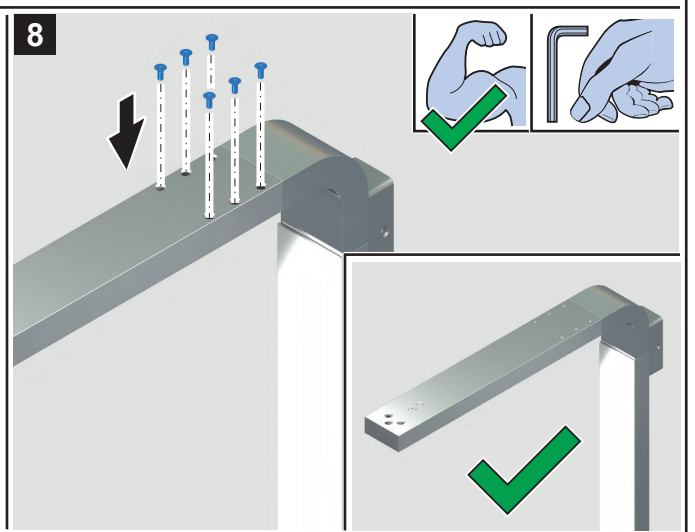
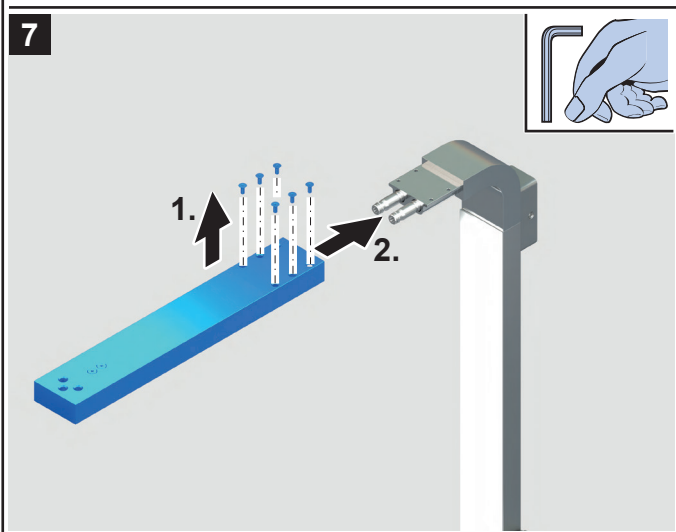
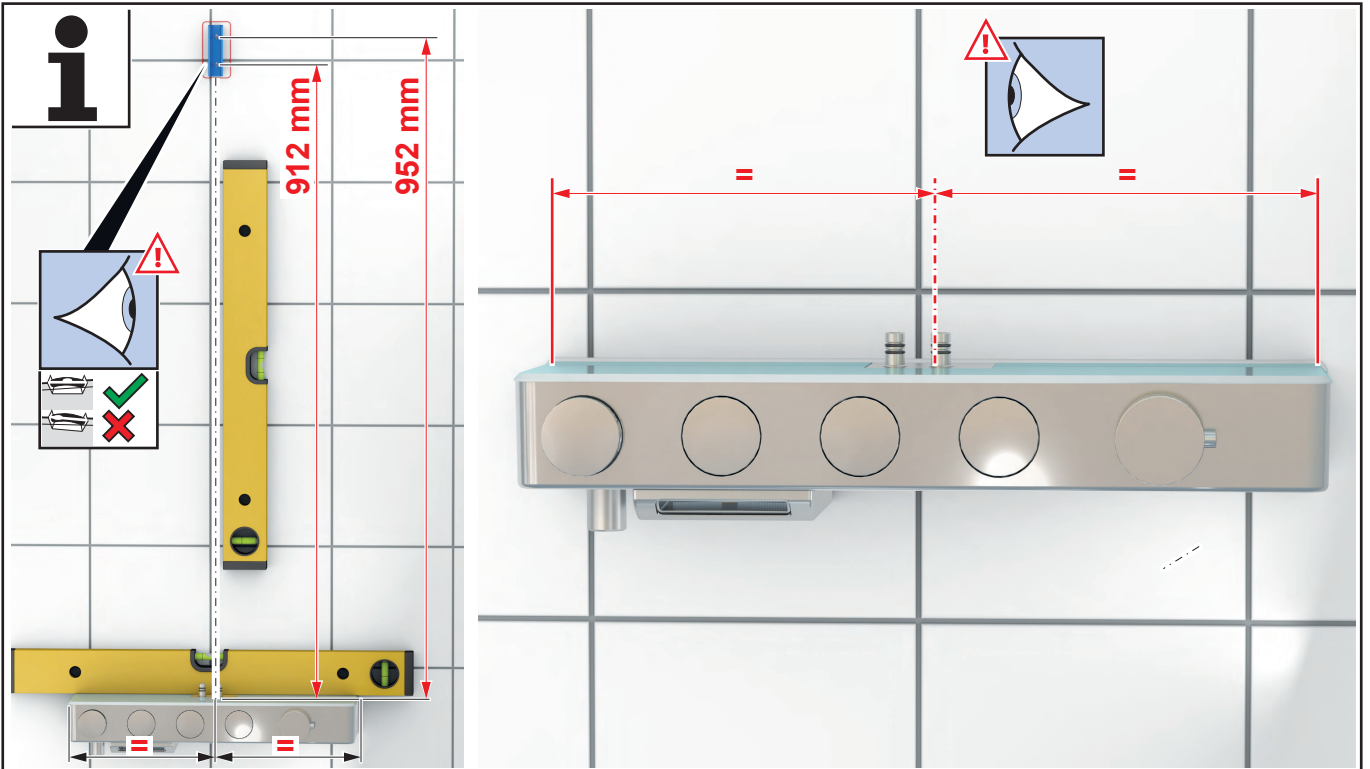

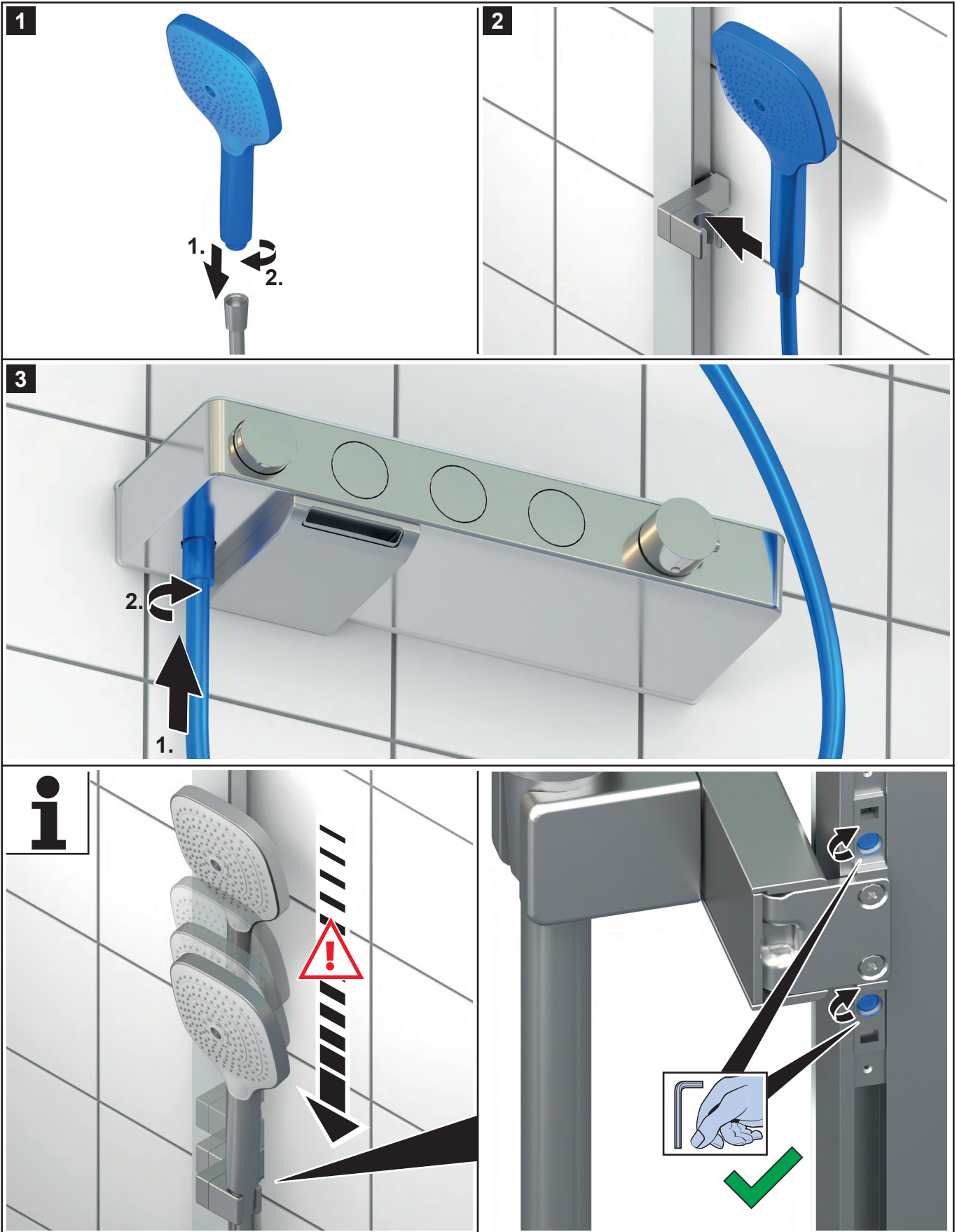

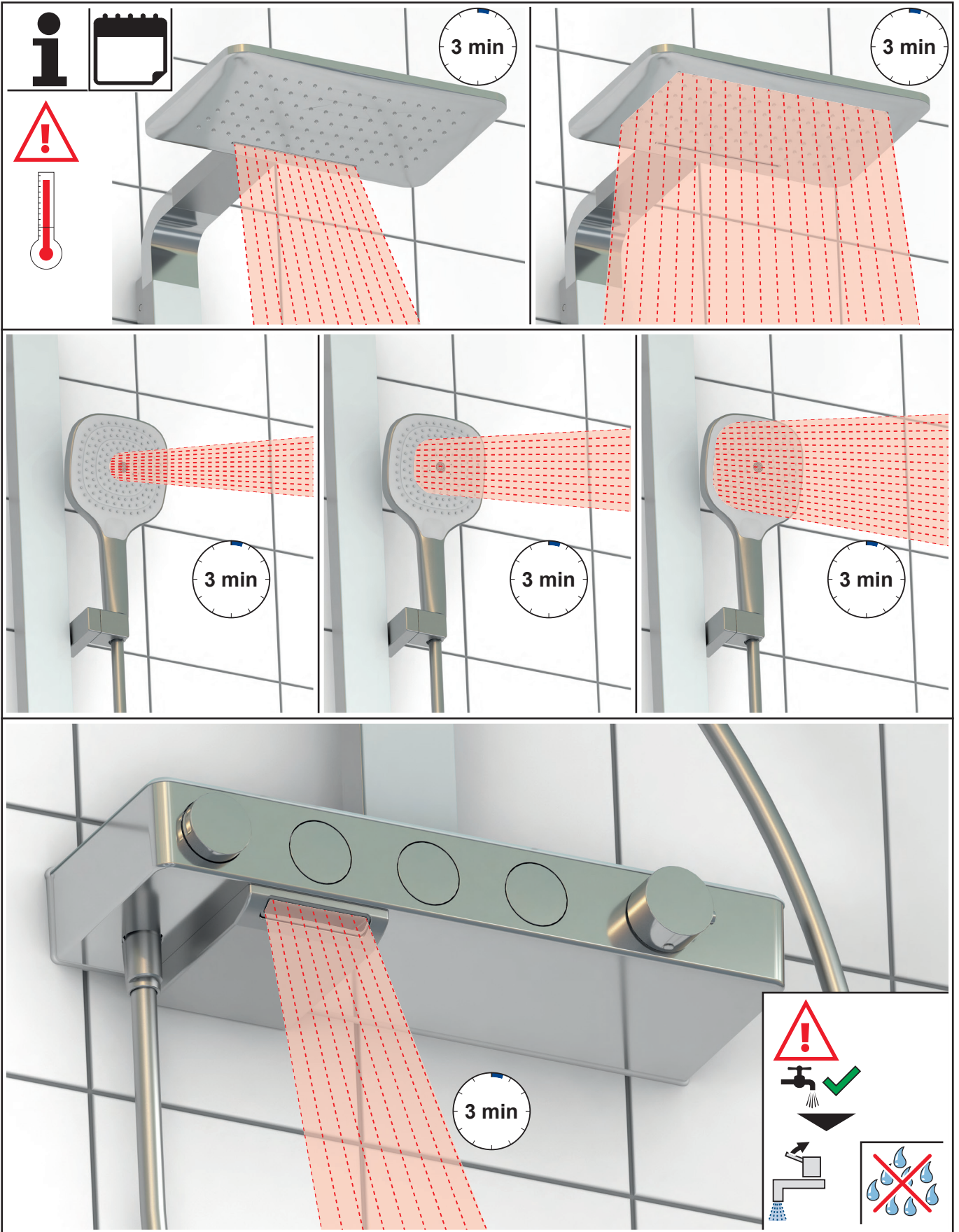



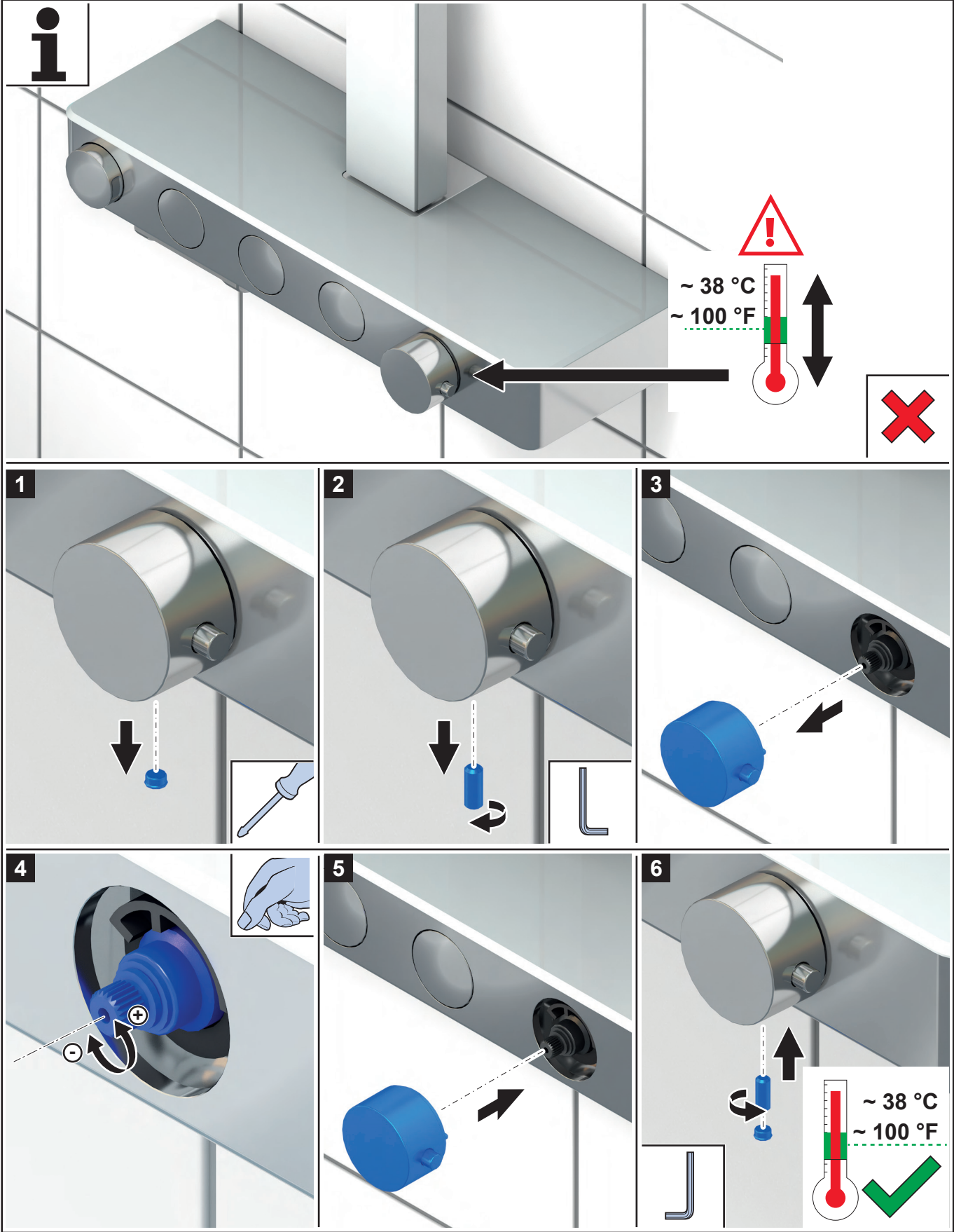

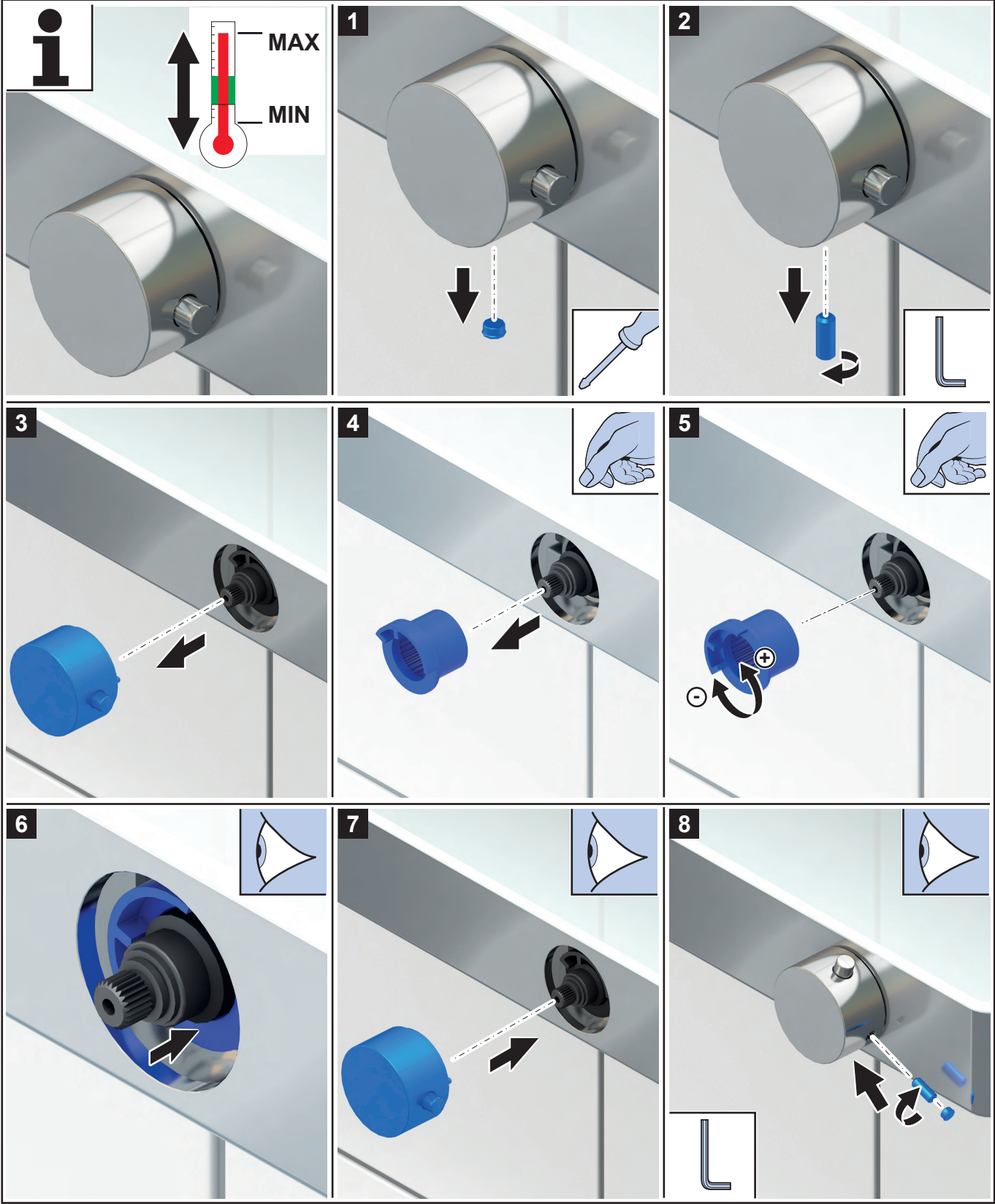

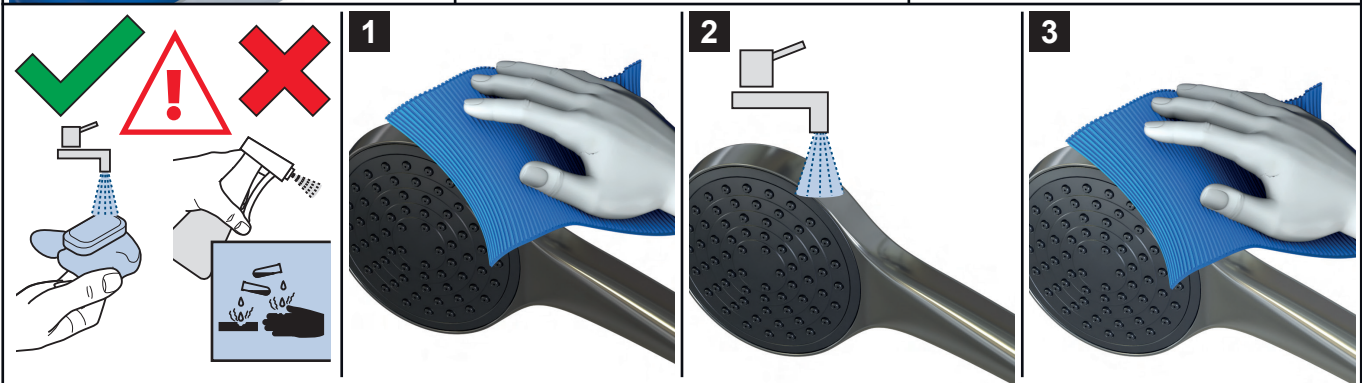
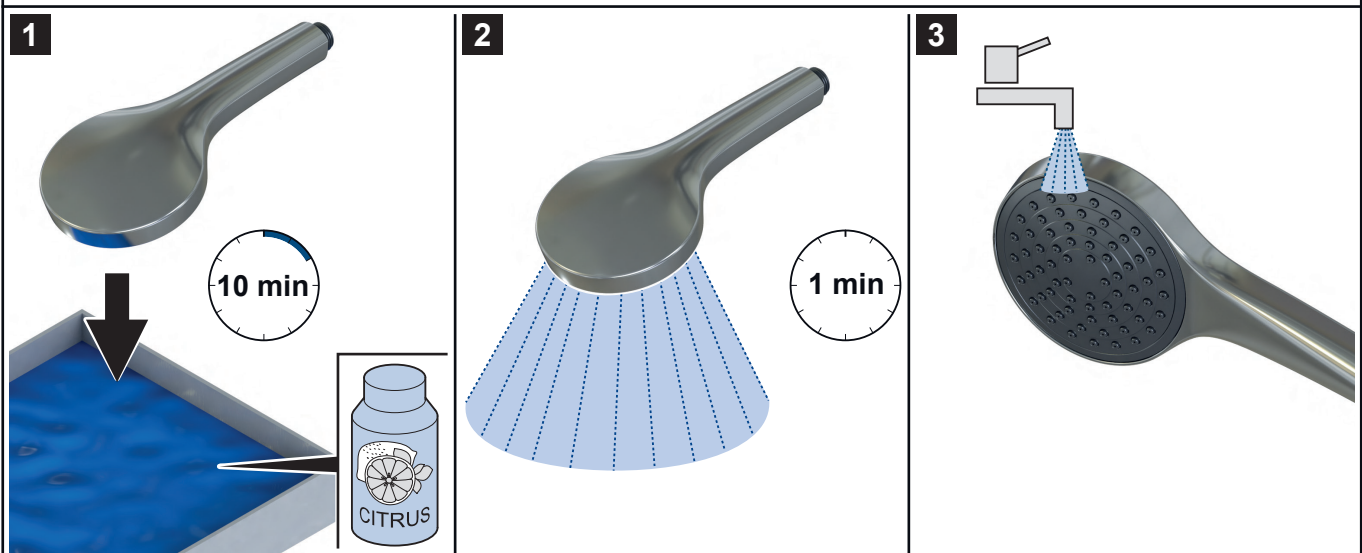
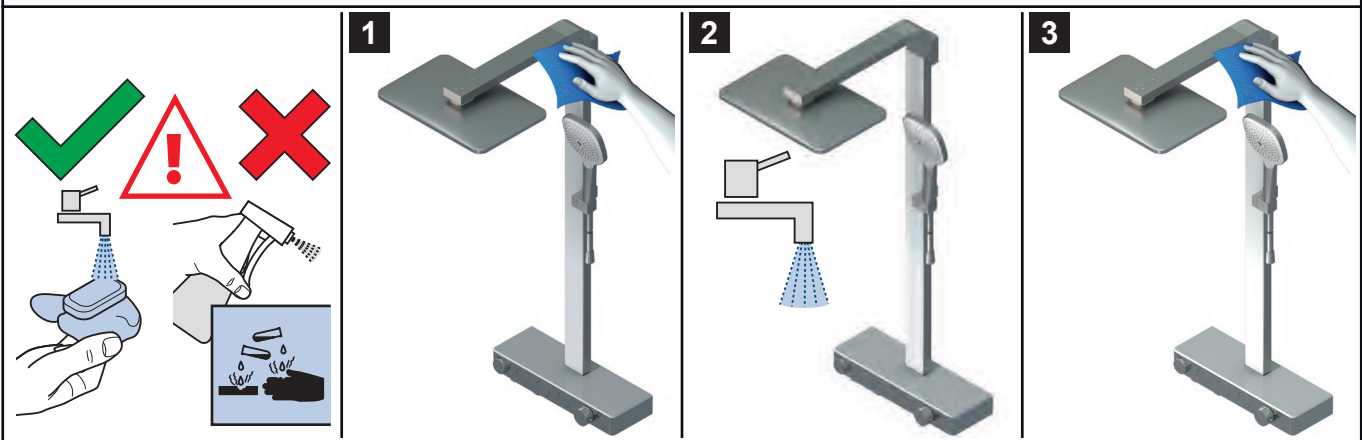
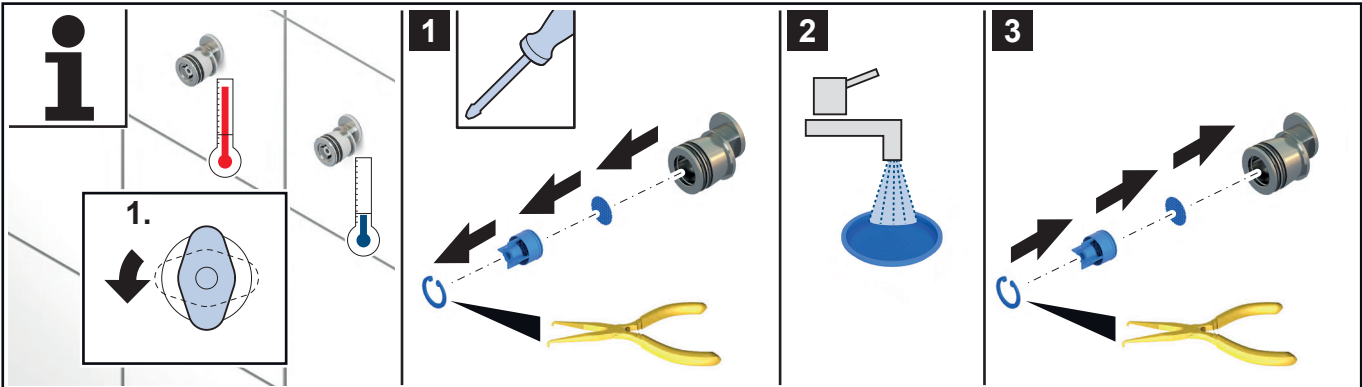

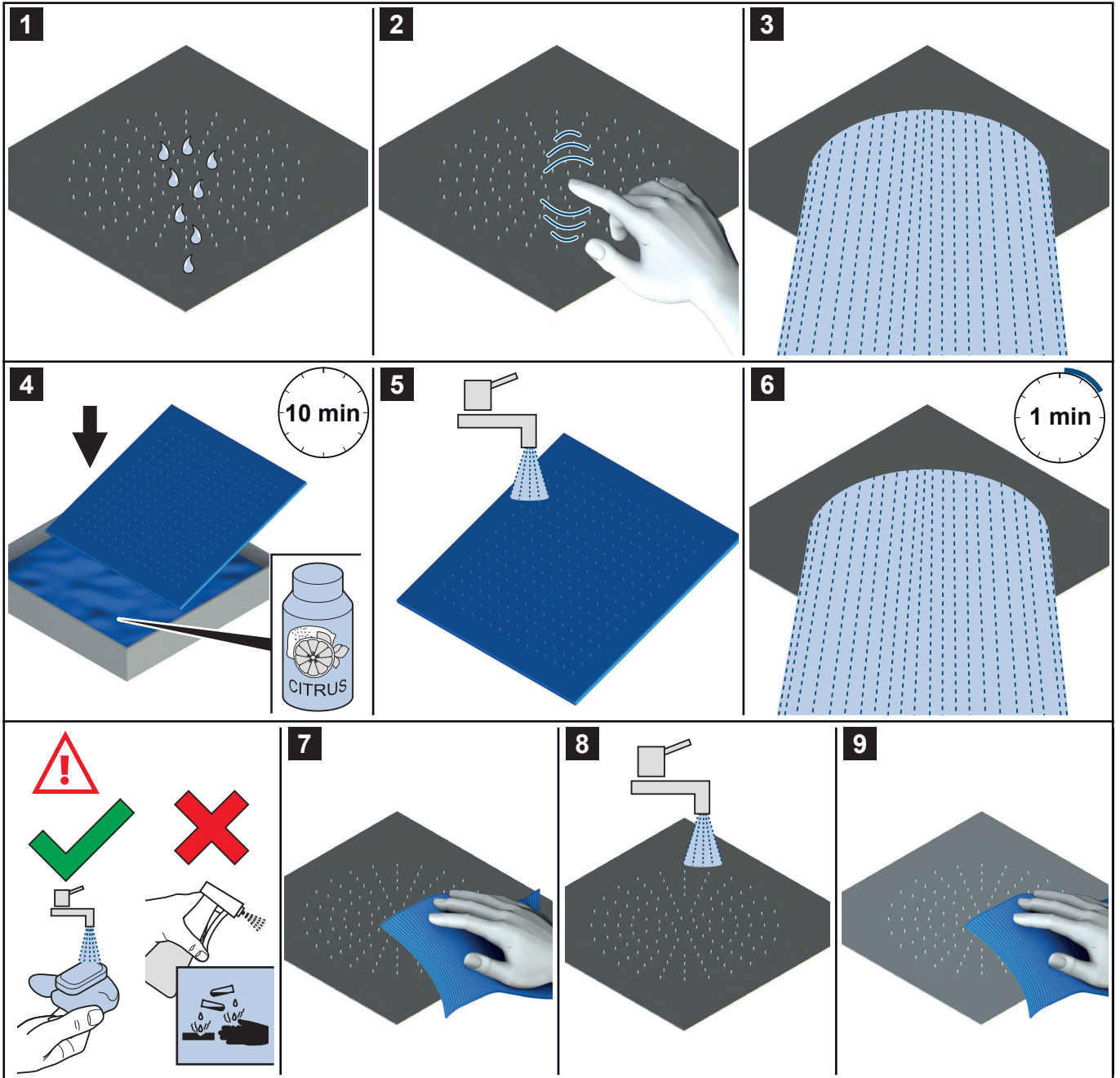

# VILLEROY & BOCH

GERMANY

*Villeroy & Boch AG  
Bathroom and Wellness Division  
Headquarters  
66693 Mettlach  
Germany*

*Tel: +49 (0) 68 64 / 81 0*

*Fax: +49 (0) 68 64 / 81 1484*